

HMW88 (2 × 4 ... 20 mA)

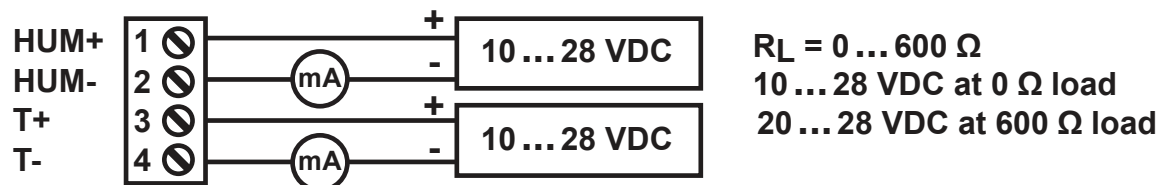

TMW88 (1 × 4 ... 20 mA)

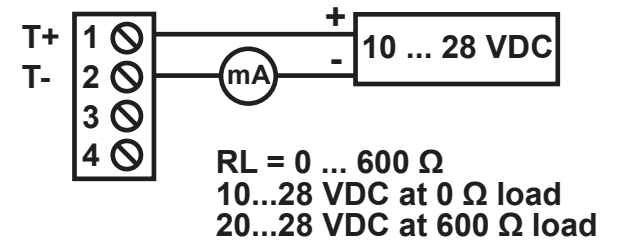

HMW89 (2 × 0 ... 10 v)

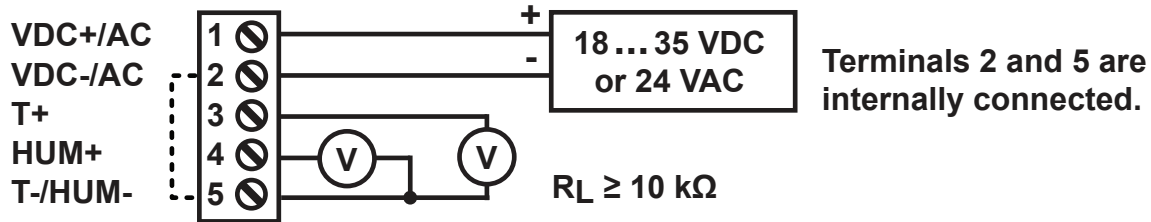

DIP switch factory default:
 HUM = Relative humidity (RH)
 Output scaling = 0 ... 100%
 Display units = Metric

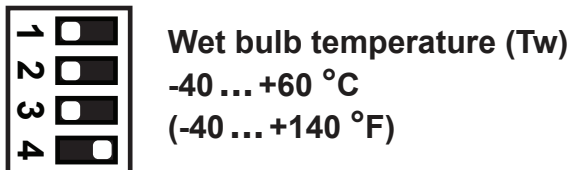
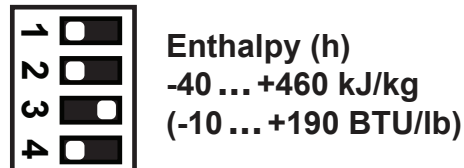
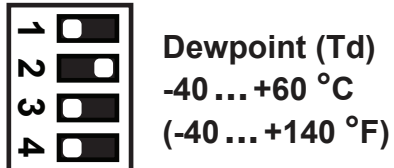
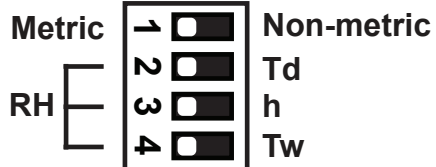

Note: Temperature (T) output always -40 ... +60 °C (-40 ... +140 °F).

Dimensions in millimeters (mm).

88

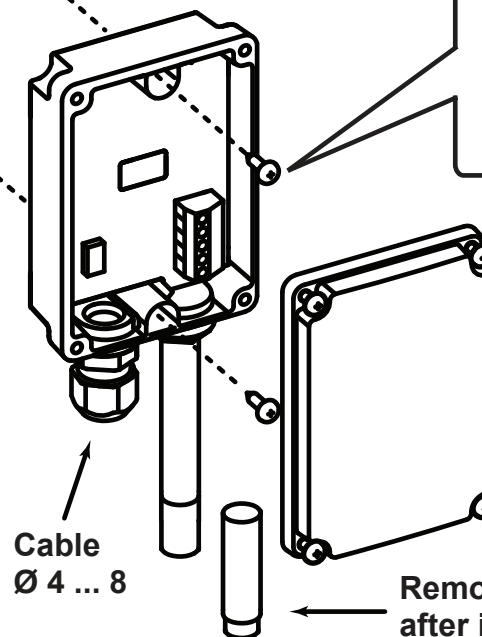

Mounting screws are not included.

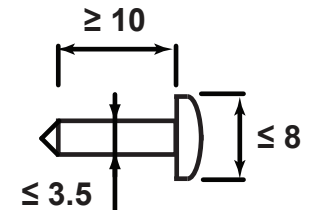

Cable
Ø 4 ... 8

Remove the plug after installation.



When transmitter cover is open, observe precautions for handling electrostatic sensitive devices.