

USER'S GUIDE

Vaisala HUMICAP[®] Humidity and Temperature Module HMM213

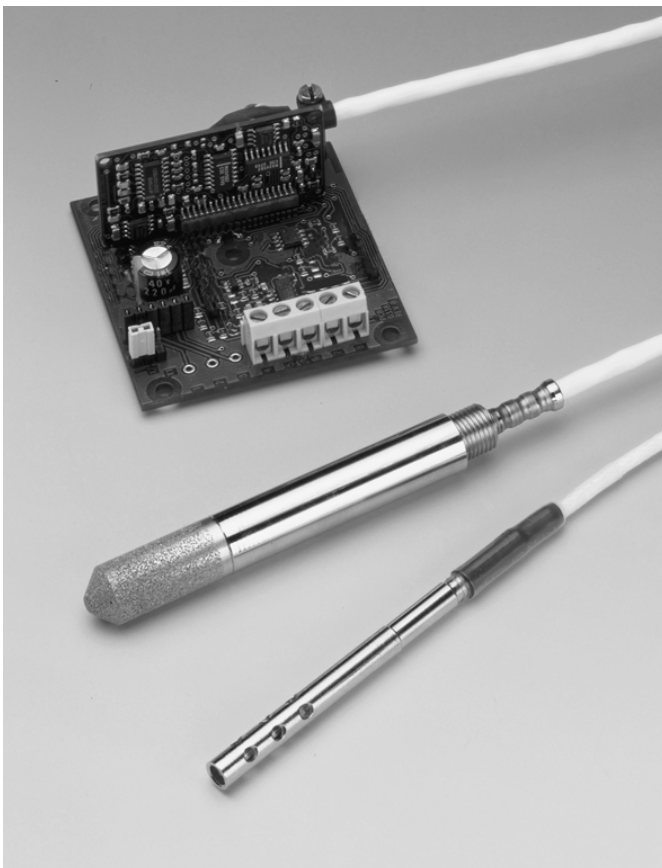

PUBLISHED BY

Vaisala Oyj
P.O. Box 26
FI-00421 Helsinki
Finland

Phone (int.): +358 9 8949 1
Fax: +358 9 8949 2227

Visit our Internet pages at <http://www.vaisala.com/>

© Vaisala 2009

No part of this manual may be reproduced in any form or by any means, electronic or mechanical (including photocopying), nor may its contents be communicated to a third party without prior written permission of the copyright holder.

The contents are subject to change without prior notice.

Please observe that this manual does not create any legally binding obligations for Vaisala towards the customer or end user. All legally binding commitments and agreements are included exclusively in the applicable supply contract or Conditions of Sale.

Table of Contents

CHAPTER 1	
GENERAL INFORMATION	9
About This Manual	9
Contents of This Manual	9
Version Information	10
Related Manuals	10
General Safety Considerations	10
Feedback	11
Product Related Safety Precautions	11
ESD Protection	11
Recycling	12
Regulatory Compliances	12
Patent Notice	13
Trademarks	13
Warranty	13
CHAPTER 2	
PRODUCT OVERVIEW	15
Introduction to HMM213	15
CHAPTER 3	
TO BE NOTED WHEN MEASURING HUMIDITY	17
CHAPTER 4	
INSTALLATION	19
Selecting Location	19
Electrical Connections	19
Dimensions	20
Serial Bus Settings	20
CHAPTER 5	
SERIAL COMMANDS	21
Output via the Serial Bus	21
R Starting the Measurement Output	21
S Stopping the Measurement Output	21
SEND Outputting a Reading Once	22
INTV Setting the Output Interval for the RUN State	22
SERI Serial Bus Settings	23
ADDR Setting the Device Address	23
UNIT Selecting the Output Units	24
VERS Displaying Software Version	24
RESET Resetting the Transmitter	24
Operating via the Serial Bus	25

SMODE Setting the Serial Interface.....	25
OPEN & CLOSE.....	25
Setting the Output Format.....	26
MCR Setting the Carriage Return On/Off.....	26
MDEC Selecting a Decimal Separator.....	26
MFLD Selecting a Field Separator.....	27
MLF Setting the Line Feed On/Off.....	27
MSPC Setting Spaces On/Off.....	28
MSYMB Setting Variable Symbols On/Off.....	28
MUNIT Setting Variable Units On/Off.....	29
 CHAPTER 6	
CALIBRATION.....	31
Humidity Calibration.....	32
Humidity Calibration with Serial Commands.....	32
Two-Point Calibration.....	32
One Point Calibration.....	33
Gain Calibration.....	33
With the Hand-Held Humidity and Temperature Meter	
HM70 or HMI41 Indicator and Calibration Cable.....	34
Calibration Table.....	36
Temperature Calibration.....	36
CT Temperature Calibration of the Warmed Humidity	
Sensor Head.....	36
Two Point Calibration.....	36
One Point Calibration.....	37
Gain Calibration.....	37
CT Temperature Calibration of the Additional Sensor	
Head.....	38
Two Point Calibration.....	38
One Point Calibration.....	39
Gain Calibration.....	39
 CHAPTER 7	
CHEMICAL PURGE OPTION.....	41
 CHAPTER 8	
MAINTENANCE.....	43
Replacing the HUMICAP®180R Sensor and the Filter.....	43
Replacing Consumables.....	43
Parts List for Consumables.....	43
 CHAPTER 9	
TROUBLESHOOTING.....	45
Troubleshooting Procedure.....	45
Technical Support.....	45
Return Instructions.....	46
Vaisala Service Centers.....	47

CHAPTER 10

TECHNICAL DATA	49
Specifications	49
Options	50

List of Figures

Figure 1	Measurement Error at 100 %RH when the Temperature Difference between the Ambient Air and the Sensor is 1 °C....	18
Figure 2	Electrical Connections	19
Figure 3	Dimensions in mm (inches)	20
Figure 4	Calibration Connector for the HM70 or HMI41	34
Figure 5	Decrease of the Sensor Gain Due to an Interfering Chemical and the Effect of the Chemical Purge Process.....	41
Figure 6	Dewpoint Temperature	49

List of Tables

Table 1	Manual Revisions	10
Table 2	Related Manuals	10
Table 3	Emission Tests	12
Table 4	Immunity Tests	12
Table 5	Output Units	24
Table 6	Greenspan's Calibration Table with Output Values According to the Chosen Scale	36
Table 7	Available Spare Parts.....	43
Table 8	Relative Humidity Specifications	49
Table 9	General Specifications	50
Table 10	Operating Voltage Specifications	50
Table 11	Modules, Sensor Heads and Outputs	50
Table 12	Cable Lengths for Sensor Heads	51
Table 13	Chemical Purge.....	51

This page intentionally left blank.

CHAPTER 1

GENERAL INFORMATION

This chapter provides general notes for the manual and the product.

About This Manual

This manual provides information for installing, operating, and maintaining Vaisala HUMICAP[®] Humidity and Temperature Module HMM213.

Contents of This Manual

This manual consists of the following chapters:

- Chapter 1, General Information, provides general notes for the manual and the product.
- Chapter 2, Product Overview, introduces the features and advantages of Vaisala HUMICAP[®] Humidity and Temperature Module HMM213.
- Chapter 3, To Be Noted When Measuring Humidity, describes issues that need to be noted in the measurement of humidity.
- Chapter 4, Installation, provides you with information that is intended to help you install this product.
- Chapter 5, Serial Commands, contains information that is needed to use the serial commands for this product.
- Chapter 6, Calibration, contains information that is needed to calibrate this product.
- Chapter 7, Chemical Purge Option, provides you with information on chemical purge.
- Chapter 8, Maintenance, provides information that is needed in basic maintenance of the product.
- Chapter 9, Troubleshooting, describes common problems, their probable causes and remedies, and contact information for technical support.
- Chapter 10, Technical Data, provides the technical data of the product.

Version Information

Table 1 Manual Revisions

Manual Code	Description
U339EN-1.2	October 1999
U339EN-1.3	This manual, December 2009 - HUMICAP® sensor type has been changed.

Related Manuals

Table 2 Related Manuals

Manual Code	Manual Name
M210316EN-A	Vaisala HUMICAP® Indicator HMI41 and Probes HMP41/45/46 User's Guide
M210777EN-B	Calibration of Digital Transmitters with Vaisala HUMICAP® Humidity Indicator HMI41 Cables 19164ZZ and 25917ZZ User's Guide
M210185EN-C	Vaisala Humidity Calibrator HMK15 User's Guide
M210297EN-E	Vaisala HUMICAP® Hand-Held Humidity and Temperature Meter HM70 User's Guide

General Safety Considerations

Throughout the manual, important safety considerations are highlighted as follows:

WARNING

Warning alerts you to a serious hazard. If you do not read and follow instructions very carefully at this point, there is a risk of injury or even death.

CAUTION

Caution warns you of a potential hazard. If you do not read and follow instructions carefully at this point, the product could be damaged or important data could be lost.

NOTE

Note highlights important information on using the product.

Feedback

Vaisala Customer Documentation Team welcomes your comments and suggestions on the quality and usefulness of this publication. If you find errors or have other suggestions for improvement, please indicate the chapter, section, and page number. You can send comments to us by e-mail: manuals@vaisala.com

Product Related Safety Precautions

The Vaisala HUMICAP[®] Humidity and Temperature Module HMM213 delivered to you has been tested for safety and approved as shipped from the factory. Note the following precautions:

WARNING	Ground the product, and verify outdoor installation grounding periodically to minimize shock hazard.
----------------	--

CAUTION	Do not modify the unit. Improper modification can damage the product or lead to malfunction.
----------------	--

CAUTION	Do not touch the sensor element.
----------------	----------------------------------

ESD Protection

Electrostatic Discharge (ESD) can cause immediate or latent damage to electronic circuits. Vaisala products are adequately protected against ESD for their intended use. However, it is possible to damage the product by delivering electrostatic discharges when touching, removing, or inserting any objects inside the equipment housing.

To make sure you are not delivering high static voltages yourself:

- Handle ESD sensitive components on a properly grounded and protected ESD workbench. When this is not possible, ground yourself to the equipment chassis before touching the boards. Ground yourself with a wrist strap and a resistive connection cord. When neither of the above is possible, touch a conductive part of the equipment chassis with your other hand before touching the boards.

- Always hold the boards by the edges and avoid touching the component contacts.

Recycling



Recycle all applicable material.



Dispose of batteries and the unit according to statutory regulations. Do not dispose of with regular household refuse.

Regulatory Compliances

The Vaisala HUMICAP[®] Humidity and Temperature Module HMM213 complies with the following performance and environmental test standards:

The emission and immunity tests have been performed according to standard EN61326-1.

Table 3 Emission Tests

Test	Setup According to
RF field emission	CISPR 22 Class B (EN55022)
Conducted emissions	CISPR 22 B (EN55022)

Table 4 Immunity Tests

Test	Setup According to
Electrostatic discharge	IEC 1000-4-2 (EN 61000-4-2)
Fast transient burst	IEC 1000-4-4 (EN 61000-4-4)
RF field immunity	IEC 1000-4-3 (EN 61000-4-3)
Conducted RF immunity NOTE: cable length max. 8 meters	IEC 1000-4-6 (EN 61000-4-6)
Surge	IEC 1000-4-5 (EN 61000-4-5)
Voltage dips, short interrupts	IEC 1000-4-11 (EN 61000-4-11)

Patent Notice

The Vaisala HUMICAP[®] Humidity and Temperature Module HMM213 is protected by the following patents and patent applications and their corresponding national rights:

Finnish patents 98861 and 99164, French patents 6650303 and 9504397, German patents 69418174 and 19513274, Japanese patents 3585973 and 2801156, UK patent 0665303, and US patent 5607564.

Trademarks

Vaisala Trademark is a registered trademark of Vaisala Oyj.

HUMICAP[®] is a registered trademark of Vaisala Oyj.

Warranty

Vaisala hereby represents and warrants all Products manufactured by Vaisala and sold hereunder to be free from defects in workmanship or material during a period of twelve (12) months from the date of delivery save for products for which a special warranty is given. If any Product proves however to be defective in workmanship or material within the period herein provided Vaisala undertakes to the exclusion of any other remedy to repair or at its own option replace the defective Product or part thereof free of charge and otherwise on the same conditions as for the original Product or part without extension to original warranty time. Defective parts replaced in accordance with this clause shall be placed at the disposal of Vaisala.

Vaisala also warrants the quality of all repair and service works performed by its employees to products sold by it. In case the repair or service works should appear inadequate or faulty and should this cause malfunction or nonfunction of the product to which the service was performed Vaisala shall at its free option either repair or have repaired or replace the product in question. The working hours used by employees of Vaisala for such repair or replacement shall be free of charge to the client. This service warranty shall be valid for a period of six (6) months from the date the service measures were completed.

This warranty is however subject to following conditions:

- a) A substantiated written claim as to any alleged defects shall have been received by Vaisala within thirty (30) days after the defect or fault became known or occurred, and

- b) the allegedly defective Product or part shall, should Vaisala so require, be sent to the works of Vaisala or to such other place as Vaisala may indicate in writing, freight and insurance prepaid and properly packed and labelled, unless Vaisala agrees to inspect and repair the Product or replace it on site.

This warranty does not however apply when the defect has been caused through

- a) normal wear and tear or accident;
- b) misuse or other unsuitable or unauthorized use of the Product or negligence or error in storing, maintaining or in handling the Product or any equipment thereof;
- c) wrong installation or assembly or failure to service the Product or otherwise follow Vaisala's service instructions including any repairs or installation or assembly or service made by unauthorized personnel not approved by Vaisala or replacements with parts not manufactured or supplied by Vaisala;
- d) modifications or changes of the Product as well as any adding to it without Vaisala's prior authorization;
- e) other factors depending on the Customer or a third party.

Notwithstanding the aforesaid Vaisala's liability under this clause shall not apply to any defects arising out of materials, designs or instructions provided by the Customer.

This warranty is expressly in lieu of and excludes all other conditions, warranties and liabilities, express or implied, whether under law, statute or otherwise, including without limitation ANY IMPLIED WARRANTIES OF MERCHANTABILITY OR OF FITNESS FOR A PARTICULAR PURPOSE and all other obligations and liabilities of Vaisala or its representatives with respect to any defect or deficiency applicable to or resulting directly or indirectly from the Products supplied hereunder, which obligations and liabilities are hereby expressly cancelled and waived. Vaisala's liability shall under no circumstances exceed the invoice price of any Product for which a warranty claim is made, nor shall Vaisala in any circumstances be liable for lost profits or other consequential loss whether direct or indirect or for special damages.

CHAPTER 2

PRODUCT OVERVIEW

This chapter introduces the features and advantages of Vaisala HUMICAP[®] Humidity and Temperature Module HMM213.

Introduction to HMM213

The HMM213 modules are designed especially for relative humidity measurements in environmental chamber applications with high temperature and humidity levels. They also measure temperature and calculate the dewpoint temperature.

The HMM213 has actually three different module options to choose from:

- Humidity and temperature module: with a standard humidity and temperature sensor head
- Dewpoint module with a warmed sensor head incorporating a composite RH and T sensor
- Humidity and temperature module with two sensor heads: with a warmed humidity sensor head incorporating a composite sensor, and an additional temperature sensor head for ambient temperature measurement

The HMM213 is a RS232 serial output module. The customer has two options for the humidity probe length. Furthermore, the module can also be ordered with a suitable cable length (0.65 m, 1.50 m, or 3.0 m). The temperature measurement range is -70 ... +180 °C).

Output parameters depend on the module type. The output parameters for the RH and T module are relative humidity and temperature. For the RH and T module with two sensor heads, the parameters also include relative humidity and temperature and for the dewpoint module, the parameter is dewpoint temperature. The dewpoint temperature range is -70 ... +100 °C.

The probes also have a selectable chemical purge option. Note that with a warmed sensor head, the probe length is always 90 mm and the sensor is protected with a sintered filter.

The HMM213 modules are connected to process control systems with screw terminals. These versatile modules incorporate the HUMICAP® 180R humidity sensor, which uses an operating principle based on changes in the capacitance of a thin polymer film as it absorbs water molecules. The HMM213 modules measure temperature with the reliable Pt 100 sensor. If the module is ordered with chemical purge option, it incorporates a composite sensor.

CHAPTER 3

TO BE NOTED WHEN MEASURING HUMIDITY

This chapter describes issues that need to be noted in the measurement of humidity.

In the measurement of relative humidity and especially in calibration, it is essential that the temperature equilibrium is reached. Even a slight difference in the temperature between the measured object and the sensor causes an error. For example, at +20 °C (+ 68 °F) and 50 %RH, a temperature difference of ± 1 °C between the measured object and the sensor causes an error of ± 3 %RH. If relative humidity is 90 %RH, the error is about ± 5.4 %RH. A graph of the measurement error at 100 %RH when the temperature difference between ambient air and the sensor is 1 °C is presented in Figure 1 on page 18.

The error is at its greatest when the temperature of the sensor differs from that of the surroundings and the humidity is high. A difference of a few degrees in temperature may cause water to condense on the sensor surface. Efficient ventilation accelerates the evaporation of the condensed water whereas in an unventilated space, it may take hours. The HUMICAP[®] 180R sensor returns to its normal functioning as soon as water has evaporated. Contaminated water condensing on the sensor may shorten its life span and alter the calibration.

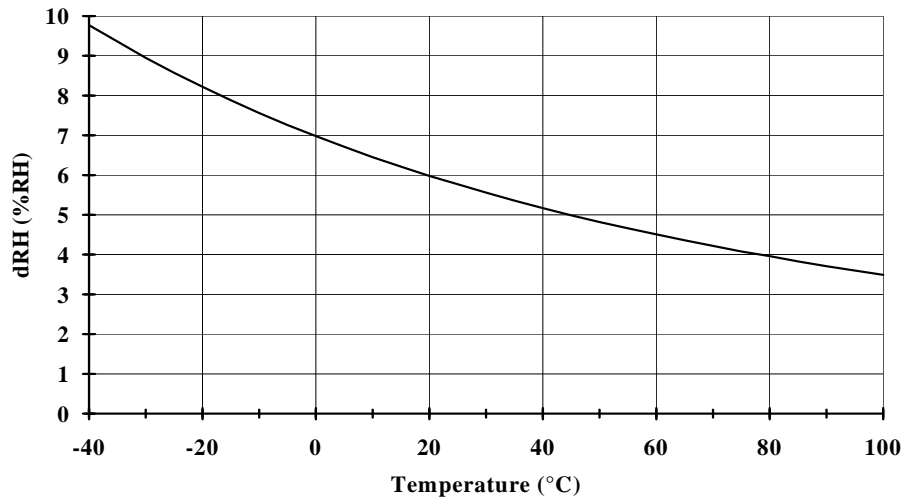

Figure 1 Measurement Error at 100 %RH when the Temperature Difference between the Ambient Air and the Sensor is 1 °C

NOTE

With a dewpoint module, the temperature equilibrium is not a problem as the temperature of the sensor head changes continuously and the sensor head has a fast humidity response.

CHAPTER 4

INSTALLATION

This chapter provides you with information that is intended to help you install this product.

Selecting Location

Finding a suitable site for HMM213 is important for getting representative ambient measurements

Select a place that gives a true picture of the environment or process and is as clean as possible. Air should flow freely around the sensor head.

Install the sensor head to a sufficient distance from the duct or chamber walls. Make sure to insert enough cable to the same space with the probe in order to prevent heat conduction. If an additional temperature probe is used, install it so that the warmed sensor head does not interfere with the measurement.

Electrical Connections

The HMM213 module is connected to a process control system with screw terminals. The wiring diagram is shown in Figure 2 below.

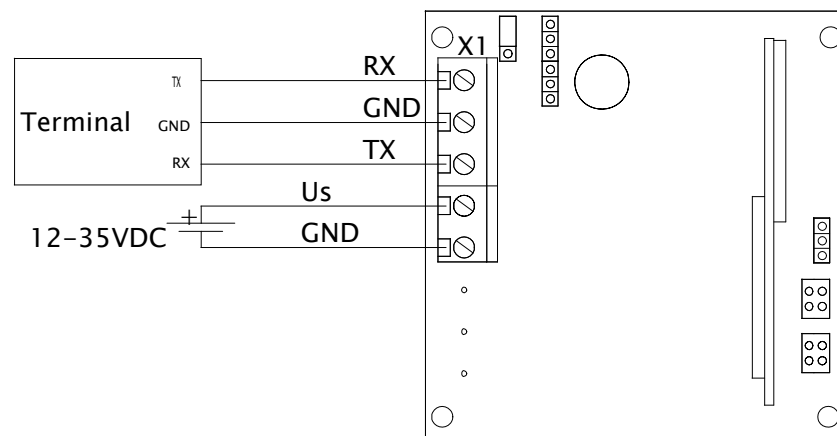

Figure 2 Electrical Connections

Dimensions

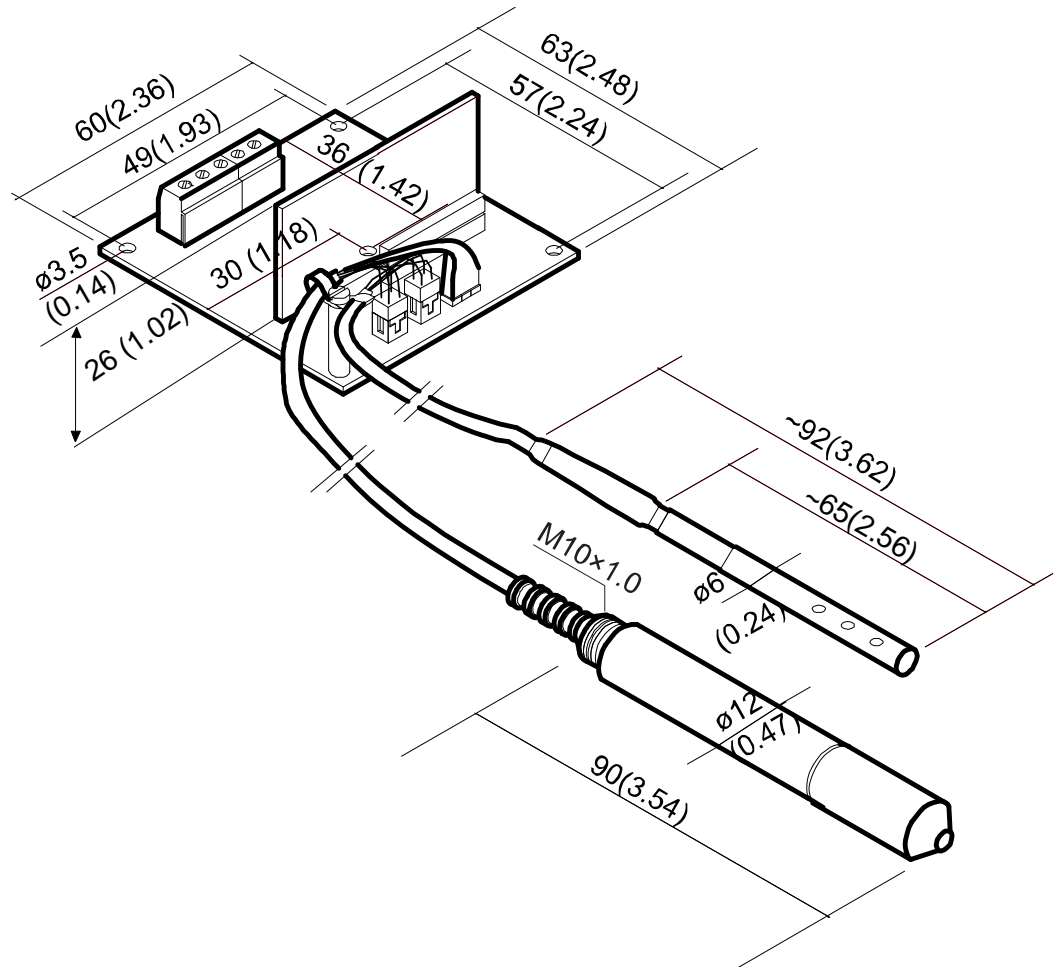

Figure 3 Dimensions in mm (inches)

Serial Bus Settings

The serial communication parameters set at factory are:

Parameter	Value
Baud	1200
Parity	None
Data bits	8
Stop bits	1

CHAPTER 5

SERIAL COMMANDS

This chapter contains information that is needed to use the serial commands for this product.

Output via the Serial Bus

R Starting the Measurement Output

R <cr>

Starts output of measurements to the peripheral devices (PC display or printer); output interval is set with command INTV.

The output format depends on the transmitter configuration and parameters in use. The order, however, is always the same: relative humidity, temperature, and dewpoint. An example:

```
RH 43.0 %RH T 21.0 'C Tdp 8.0 'C <cr><lf>
```

When the transmitter sends out the readings, the serial interface does not echo any commands; the only command that can be used is S (stop).

S Stopping the Measurement Output

S<cr>

Ends the RUN state; after this command all other commands can be used.

SEND Outputting a Reading Once

SEND <cr> in STOP state

or

SEND aa <cr> in POLL state

aa = address of the transmitter when more than one transmitter is connected to a serial bus (0 ... 99; set with command ADDR)

Outputs the current measurement readings via the serial line. The output format depends on which parameters the transmitter can output. Output types are:

```
"RH 32.25 %RH T 25.74 'C ",<cr><lf>
"Td 7.93 'C",<cr><lf>
```

INTV Setting the Output Interval for the RUN State

INTV xxx yyy <cr>

xxx = output interval (0 ... 255)
 0: no pause between outputs
 yyy = unit (s, min or h)

Sets the output interval when the transmitter outputs measurement readings to a peripheral device.

For example:

```
>INTV 10 MIN<cr>
Output intrv. : 10 min
```

SERI Serial Bus Settings

SERI b p d s <cr>

b = bauds (150, 300, 600, 1200*, 2400, 4800)
 p = parity (n = none*, e = even, o = odd)
 d = data bits (7 or 8*)
 s = stop bits (1* or 2)
 * factory setting

Giving the plain command outputs the current settings:

```
>SERI <cr>
Communication parameters       : 1200 N 8 1
>
```

Example of changing the serial bus settings:

```
>seri 1200 e 7 1
Communication parameters       : 1200 E 7 1
Set terminal settings accordingly
>
```

ADDR Setting the Device Address

ADDR x

x = 0 ... 99

The command is used to give an address for one device. The address is necessary for communication with a specific transmitter in POLL mode, when there are several modules connected to one serial bus

```
>ADDR 11
Address                         :     11
>
```

Operating via the Serial Bus

SMODE Setting the Serial Interface

SMODE xxxx<cr>

xxxx =	STOP, RUN or POLL
In STOP mode:	measurements output only by command, all commands can be used
In RUN mode:	outputting automatically, only command S can be used
In POLL mode:	measurements output only with command SEND. When in POLL mode, the output state is changed as follows:

OPEN aa <cr>
SMODE xxxx<cr>

aa =	address of the transmitter
xxxx =	STOP, RUN or POLL

The OPEN command sets the bus temporarily in STOP MODE so that the SMODE command can be given. For example:

```
>SMODE <cr>                (which mode is in use at the moment)
Output mode                 : STOP
>SMODE STOP <cr>           (setting STOP mode)
Output mode                 : STOP
>
```

OPEN & CLOSE

OPEN nn <cr>

nn =	address of the transmitter (0 ... 99)
------	---------------------------------------

CLOSE <cr>

In STOP mode:	command OPEN has no effect, CLOSE sets the transmitter in POLL mode
In POLL mode:	command OPEN sets the transmitter temporarily in STOP mode, command CLOSE returns the instrument to POLL mode

When more than one transmitter is connected to the same serial bus, the POLL mode makes it possible to communicate with the transmitters. For example, a relative humidity calibration is performed at transmitter 2 (<bel> = ASCII 7):

```
>OPEN 2 <cr>
<cr><lf> 'HMM nn line opened for operator commands'
<cr><lf><bel>
>CRH <cr>
...
>CLOSE <cr>
<cr><lf><lf> 'line closed' <cr><lf>
```

Setting the Output Format

MCR Setting the Carriage Return On/Off

MCR x

```
x =          ON/OFF

>MCR ON
Msg. cr          : ON
>
```

MDEC Selecting a Decimal Separator

MDEC x

```
x =          a character, TAB, SP, CR, LF

>MDEC .
dec. separator   : .
>R
RH 60.50 %RH    T 23.90 'C
RH 60.50 %RH    T 23.90 'C
...
>MDEC Z
dec. separator   : Z
>R
RH 60Z56 %RH    T 23Z89 'C
RH 60Z56 %RH    T 23Z90 'C
...
>
```

MFLD Selecting a Field Separator

MFLD x

x = a character, TAB, SP, CR, LF

```
>MFLD SP
fld. separator      : SP
>R
RH 60.53 %RH T 23.89 'C
RH 60.52 %RH T 23.89 'C
...

>MFLD TAB
fld. separator      : TAB
>R
RH 60.58 %RH      T 23.89 'C
RH 60.57 %RH      T 23.89 'C
...
```

MLF Setting the Line Feed On/Off

MLF x

x = ON/OFF

```
>MLF OFF
Msg. lf            : OFF
>R
>RH 60.78 %RH      T 23.84 'C   (repeating values)

>MLF ON
Msg. lf            : ON
>R
RH 60.85 %RH      T 23.86 'C
RH 60.80 %RH      T 23.86 'C
...
```

MSPC Setting Spaces On/Off

MSPC x

x = ON/OFF

MSPC sets on/off the outputting of a space before and after the values of the message.

```
>MSPC OFF
Msg. space           : OFF
>R
RH57.52%RH          T73.81 'F
RH57.50%RH          T73.77 'F
RH57.44%RH          T73.76 'F
>MSPC ON
Msg. space           : ON
>R
RH 57.55 %RH        T 73.78 'F
RH 57.55 %RH        T 73.78 'F
RH 57.48 %RH        T 73.82 'F
>
```

MSYMB Setting Variable Symbols On/Off

MSYMB x

x = ON/OFF

```
>MSYMB ON
Msg. symbol          : ON
>R
RH 60.86 %RH        T 23.87 'C
RH 60.86 %RH        T 23.87 'C
...
>MSYMB OFF
Msg. symbol          : OFF
>R
60.91 %RH           23.87 'C
60.84 %RH           23.87 'C
...

```

MUNIT Setting Variable Units On/Off

MUNIT x

x = ON/OFF

```
>MUNIT ON
Msg. unit           : ON
>R
RH 61.01 %RH      T 23.85 'C
RH 60.99 %RH      T 23.85 'C
...
>MUNIT OFF
Msg. unit           : OFF
>R
RH 60.97          T 23.84
RH 60.98          T 23.87
...
>
```

This page intentionally left blank.

CHAPTER 6

CALIBRATION

This chapter contains information that is needed to calibrate this product.

Vaisala recommends a recalibration of the HMM213 module after six months of use. After the first recalibration, the recommended calibration interval is approximately 12 months. However, please note that these intervals depend on the operating conditions and the required accuracy. When calibrating humidity instruments, it is important that the probe, the reference instrument, and the calibrator are in thermal equilibrium. Therefore, always allow enough time for stabilization before starting the actual calibration.

- Calibration in the chamber: leave the calibrator (for example, the HMK15) in the chamber overnight with the chamber door open.
- Calibration of a humidity and temperature module: allow at least one hour for the stabilization of the calibrator (for example, HM70 hand-held humidity and temperature meter with a reference probe).
- Calibration of a dewpoint module or of a humidity and temperature module with two sensor heads: allow at least 3 hours for stabilization if the sensor head is in such an environment that the warming function has been active.
- Calibration of a module with chemical purge option: chemical purge is activated when the power is connected. When calibrating a probe, turn the power on with the sintered stainless steel filter on the probe, wait for 10 minutes, and remove the filter. Let stabilize and perform a calibration. NOTE: do not turn the power off during calibration.

NOTE

When calibrating a module with the **warmed sensor head**, deactivate first the heating by using command **HEAT 0 <cr>**. If the sensor head is in such an environment that the warming function has been active, allow at least 3 hours for stabilization. After calibration, the heating is reactivated with command **HEAT 1 <cr>**.

Humidity Calibration

A one-point calibration can be done against an accurate transfer standard in the field and a two-point calibration using saturated salt solutions in controlled conditions (HMK15). You can also send the instrument to Vaisala or a Vaisala representative for recalibration.

Humidity Calibration with Serial Commands

Two-Point Calibration

CRH <cr>

With this command, the transmitters can be calibrated at two humidity points against a reference.

An example of performing the two point calibration with the HMK15:

1. Leave the calibrator and the probe for at least 1 hour in the same environment so that their temperatures have time to equalize.
2. Remove the sintered filter and insert the probe into the measurement hole of the LiCl salt chamber in the humidity calibrator.
3. Give the command CRH and the following text appears:

```
>CRH <cr>
RH : 12.00   Ref1 ?
```

4. Wait for 20 to 40 minutes. If the stabilization of the sensor to the humidity in the calibrator needs to be monitored, the measurement output can be repeated by <cr> at Ref1 and Ref2.

```
>CRH <cr>
RH : 12.00   Ref1 ? <cr>
RH : 11.70   Ref1 ? <cr>
RH : 11.50   Ref1 ? <cr>
...
```

5. Check the temperature and read the closest corresponding RH value in the calibration table. Give the value and acknowledge it with enter.

```
RH : 12.00   Ref1 ? 11.3 <cr>
Press any key when ready ...
```

6. Insert the probe into the measurement hole of the NaCl chamber. Wait for 20 to 40 minutes.
7. Check the temperature and read the closest corresponding RH value in the calibration table. Give the value and acknowledge it with enter.

```
RH : 76.00   Ref2 ? 75.5 <cr>
>
```

8. Check again the reading at the first point and repeat the procedure if necessary.

One Point Calibration

CRH xx.xx yy.yy

xx.xx = current humidity
yy.yy = offset calibration

Example of performing the offset calibration in one reference point:

```
>crh 54.63 2.3
>
```

Use an accurate and calibrated reference only.

Gain Calibration

CRH 0 0 xx.xx yy.yy

xx.xx = current humidity
yy.yy = correction ($RH_{ref} - RH_{measured}$)

Example of performing the gain calibration in one reference point:

```
>crh 0 0 73.60 1.7
>
```

Use an accurate and calibrated reference only.

With the Hand-Held Humidity and Temperature Meter HM70 or HMI41 Indicator and Calibration Cable

The HMM213 module can be calibrated with the Hand-Held Humidity and Temperature Meter HM70 or HMI41 indicator and an appropriate calibration cable (for HM70: 27159ZZ; for HMI41: 19164ZZ).

Connect the cable to the test connector of the HMM213 module and insert the jumper as indicated in Figure 4 below. For detailed instructions, see the following documents:

- Vaisala HUMICAP® Indicator HMI41 and Probes HMP41/45/46 User's Guide
- Vaisala HUMICAP® Hand-Held Humidity and Temperature Meter HM70
- Calibration of Digital Transmitters with Vaisala HUMICAP® Humidity Indicator HMI41 Cables 19164ZZ and 25917ZZ User's Guide

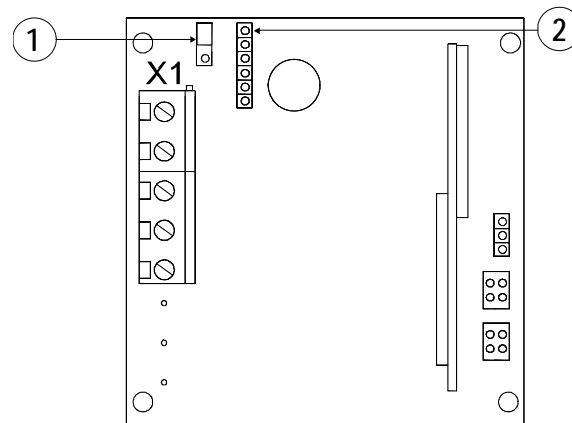

Figure 4 Calibration Connector for the HM70 or HMI41

The following numbers refer to Figure 4 above:

- 1 = For calibration with the HM70 or HMI41, insert the jumper as indicated here.
- 2 = Calibration connector for the HM70 or HMI41

NOTE

The serial communication parameters are:
1200 bauds, no parity, 8 data bits, 1 stop bit

NOTE

When the connection is being established, the message 'CON ERROR' blinks on the HMI41 display for a couple of times after which measurement readings appear. This is quite normal and requires no action; however, if the message is not replaced by measurement readings, it is an indication of an operation error.

Calibration Table

Table 6 Greenspan's Calibration Table with Output Values According to the Chosen Scale

Temperature	°C	15	20	25	30	35
	°F	59	68	77	86	95
LiCl	%RH	*)	11.3	11.3	11.3	11.3
NaCl	%RH	75.6	75.5	75.3	75.1	74.9

*) If the LiCl solution is used or stored in temperatures below +18 °C (+64 °F), the equilibrium humidity of the salt solution may change permanently.

Temperature Calibration

NOTE

The temperature channel of the HMM213 is very stable and the modules have been calibrated at the factory. Unless there is a strong reason to believe that the adjustments have changed, do not perform a temperature calibration. This is a very demanding procedure and requires both expertise and extremely accurate references. Furthermore, it is important to allow enough time for the stabilization during calibration.

If for some reason it is necessary to perform the temperature calibration, follow attentively the instructions given below. Use an accurate and calibrated reference only.

CT Temperature Calibration of the Warmed Humidity Sensor Head

Two Point Calibration

```
CT <cr>
```

Using this command the transmitters can be calibrated against an accurate reference, such as a Pt 100 simulator. A two-point calibration is performed as follows:

```
>CT <cr>
T : 23.22 Ref1 ? 23.3 <cr>
Press any key when ready ...
T : 101.42 Ref2 ? 101 <cr>
```

If the stabilization of the sensor to the temperature of the reference needs to be monitored, the measurement output can be repeated with <cr> at Ref1 and Ref2:

```
>CTA <cr>
T : 23.19 Ref1 ?    <cr>
T : 23.20 Ref1 ?    <cr>
.
.
T : 23.22 Ref1 ?    23.3 <cr>
Press any key when ready ...
T : 101.42 Ref2 ?    101 <cr>
```

One Point Calibration

CT xx.xx yy.yy

xx.xx = current temperature

yy.yy = offset correction

Example of performing the offset calibration in one reference temperature:

```
>CT 21.2 2.3
>
```

Use an accurate and calibrated reference only.

Gain Calibration

CT xx 0 yy.yy zz.zz

xx = temperature in which there is no changes in offset

yy.yy = current temperature

zz.zz = correction ($T_{\text{ref}} - T_{\text{measured}}$)

Example of performing the gain calibration in one reference point without changing the offset at 0 °C:

```
>CT 0 0 101 -0.5
>
```

Example of performing the gain calibration in one reference point without changing the offset at -70 °C:

```
>CT -70 0 101 -0.5
>
```

Use an accurate and calibrated reference only.

CT Temperature Calibration of the Additional Sensor Head

Two Point Calibration

CTA <cr>

Using this command the transmitters can be calibrated against an accurate reference, such as a Pt 100 simulator. A two-point calibration is performed as follows:

```
>CTA <cr>
T : 23.19 Ref1 ? 23.3 <cr>
Press any key when ready ...
T : 101.42 Ref2 ? 101 <cr>
```

If the stabilization of the sensor to the temperature of the reference needs to be monitored, the measurement output can be repeated with <cr> at Ref1 and Ref2:

```
>CTA <cr>
T : 23.19 Ref1 ? <cr>
T : 23.20 Ref1 ? <cr>
.
.
.
T : 23.22 Ref1 ? 23.3 <cr>
Press any key when ready ...
T : 101.42 Ref2 ? 101 <cr>
```

One Point Calibration

CTA xx.xx yy.yy

xx.xx = current temperature

yy.yy = offset correction

Example of performing the offset calibration in one reference temperature:

```
>CTA 21.2 2.3  
>
```

Use an accurate and calibrated reference only.

Gain Calibration

CTA xx 0 yy.yy zz.zz

xx = temperature in which there is no changes in offset

yy.yy = current temperature

zz.zz = correction ($T_{\text{ref}} - T_{\text{measured}}$)

Example of performing the gain calibration in one reference point without changing the offset at 0 °C:

```
>CTA 0 0 101 -0.5  
>
```

Example of performing the gain calibration in one reference point without changing the offset at -70 °C:

```
>CTA -70 0 101 -0.5  
>
```

Use an accurate and calibrated reference only.

This page intentionally left blank.

CHAPTER 7

CHEMICAL PURGE OPTION

This chapter provides you with information on chemical purge.

In some applications, the sensor gain may decrease gradually due to interference caused by some chemical present in the ambient air (see Figure 5 below). The sensor polymer absorbs the interfering chemical; this reduces its water absorption ability and so decreases the sensor gain. In chemical purge, the interfering chemical is evaporated by heating the humidity sensor to a temperature level of approximately +160 °C. Automatic chemical purge takes place at startup.

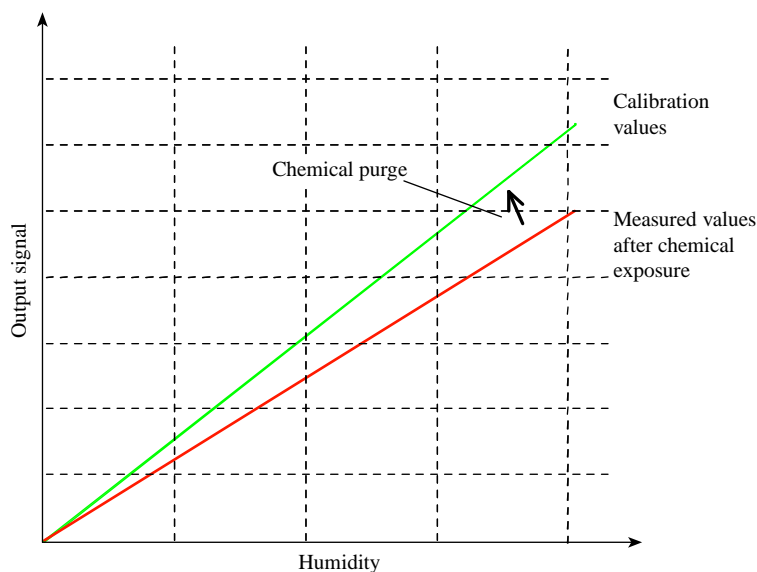

Figure 5 Decrease of the Sensor Gain Due to an Interfering Chemical and the Effect of the Chemical Purge Process

The sensor with chemical purge option is a composite sensor in which the HUMICAP[®] and Pt 100 temperature sensors are attached to each other. Chemical purge option requires that the sensor is protected with a stainless steel sintered filter (part no. HM46670).

This page intentionally left blank.

CHAPTER 8

MAINTENANCE

This chapter provides information that is needed in basic maintenance of the product.

Replacing the HUMICAP[®]180R Sensor and the Filter

Remove the damaged sensor and insert a new one. Handle the sensor by the plastic socket. Recalibrate the transmitter.

CAUTION	Do not touch the sensor element.
----------------	----------------------------------

Replace a dirty filter to ensure a maximum lifetime and a fast response for the sensor.

Replacing Consumables

This section describes how to replace consumables.

Parts List for Consumables

Table 7 Available Spare Parts

Spare Part	Order Code
HUMICAP [®] 180R Sensor	HUMICAP180R
Stainless steel sintered filter	HM46670

This page intentionally left blank.

CHAPTER 9

TROUBLESHOOTING

This chapter describes common problems, their probable causes and remedies, and contact information for technical support.

Troubleshooting Procedure

When troubleshooting the product, write a problem report consisting of the following issues:

- What failed (what worked / did not work)?
- Where did it fail (location and environment)?
- When did it fail (date, immediately / after a while / periodically / randomly)?
- How many failed (only one defect / other same or similar defects / several failures in one unit)?
- What was connected to the product and to which connectors?
- Input power source type, voltage and list of other items (lighting, heaters, motors etc.) that were connected to the same power output.
- What was done when the failure was noticed?

Technical Support

For technical questions, contact the Vaisala technical support:

E-mail helpdesk@vaisala.com

Fax +358 9 8949 2790

Return Instructions

If the product needs repair, please follow the instructions below to speed up the process and to avoid extra costs to you.

1. Read the section Warranty on page 13.
2. Contact a Vaisala Service Center or a local Vaisala representative. The latest contact information and instructions are available from www.vaisala.com. Addresses of the Service Centers are provided in section Vaisala Service Centers on page 47.
Please have the following information on hand:
 - serial number of the unit
 - date and place of purchase or last calibration
 - description of the fault
 - circumstances in which the fault occurs/occurred
 - name and contact information of a technically competent person who can provide further information on the problem
3. Pack the faulty product in a strong box of adequate size, with proper cushioning material to avoid damage.
4. Include the information specified in step 2 in the box with the faulty product. Also include a detailed return address.
5. Ship the box to the address specified by your Vaisala contact.

Vaisala Service Centers

Vaisala Service Centers perform calibrations and adjustments as well as repair and spare part services. See contact information below.

Vaisala Service Centers also offer accredited calibrations, maintenance contracts, and a calibration reminder program. Do not hesitate to contact them to get further information.

European Service Center (Finland)

Controlled Environments and Instruments

Vanha Nurmijärventie 21, 01670 Vantaa, FINLAND.

Phone: +358 9 8949 2658, Fax: +358 9 8949 2295

North American Service Center

Controlled Environments and Instruments

10-D Gill Street, Woburn, MA 01801, USA.

Phone: 800-408-9456, Fax: +1 781 933 8029

Japan Service Center

42 Kagurazaka 6-Chome, Shinjuku-ku, Tokyo 162-0825, JAPAN.

Phone: +81 3 3266 9611, Fax: +81 3 3266 9610

China Service Center

Floor 2, EAS Building, No. 21, Xiao Yun Road, Dongsanhuan Beilu,

Chaoyang District, Beijing 100027, CHINA.

Phone: +86 10 8526 1199, Fax: +86 10 8526 1155

www.vaisala.com

This page intentionally left blank.

CHAPTER 10

TECHNICAL DATA

This chapter provides the technical data of the product.

Specifications

Table 8 Relative Humidity Specifications

Property	Description / Value
Measurement range	0 ... 100 %RH
Accuracy (including non-linearity, hysteresis and repeatability)	±2 %RH (0 ... 90 %RH) ±3 %RH (90 ... 100 %RH)
Response time (90%) at +20 °C in still air (with sintered filter)	60 s
Typical temperature dependence of electronics	0.02 %RH /°C
Humidity sensor	HUMICAP®180R
Temperature measurement range	-70 ... +180 °C
Typical accuracy of electronics at +20 °C	±0.1 °C
Typical temperature dependence of electronics	0.0025 °C/°C
Temperature sensor	Pt 100 RTD 1/3 IEC 751 Class B

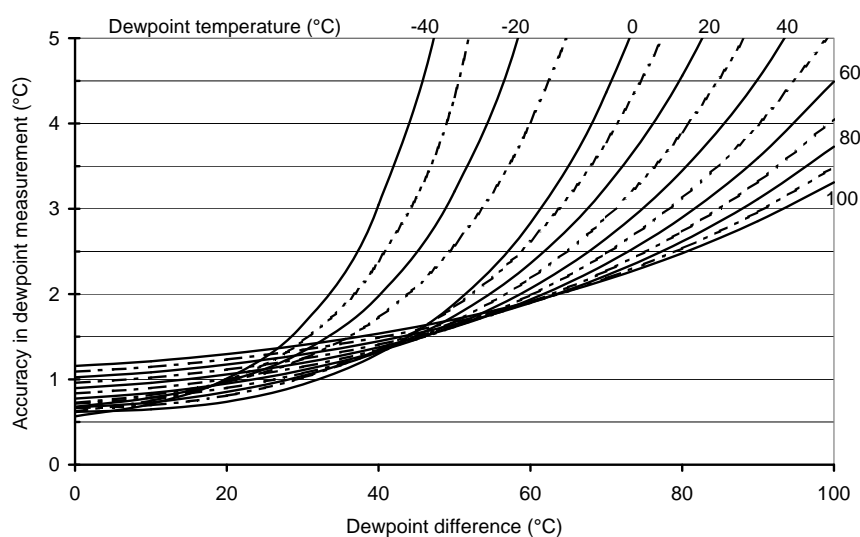

Figure 6 Dewpoint Temperature

Table 9 General Specifications

Property	Description / Value
Operating temperature range Probe Electronics	-70 ... +180 °C -5 ... +55 °C
Storage temperature range (electronics)	-40 ... +70 °C
Sensor protection: Standard	Stainless steel sintered filter
Connections	Screw terminals for 0.5 ... 1.5 mm ² wires

Table 10 Operating Voltage Specifications

Property	Value
Operating voltage	DC: 10 ... 35 V AC: 9 ... 24 V

NOTE

AC supply only possible without warming or chemical purge option.

Current consumption without warming or chemical purge option	
Voltage output:	12 mA at 35 VDC 20 mA at 24 VAC
Average power needed during warming (option)	1 W (100 ... 300 mA modulated current)
Maximum power needed during chemical purge (option):	1.4 W (100 ... 300 mA modulated current)

Options

Table 11 Modules, Sensor Heads and Outputs

Module	Sensor Heads	Output
RH and T module	One sensor head	RH and T output
Dewpoint module	Warmed humidity sensor head	Dewpoint output
RH and T module with two sensor heads	Warmed humidity sensor head	RH and T output

Table 12 Cable Lengths for Sensor Heads

Sensor Head	Cable Length
Humidity sensor head	65, 150, 300 cm
Optional T sensor head/ module with two sensor heads	150 or 300 cm

Table 13 Chemical Purge

Module	Automatic Chemical Purge at Startup
RH and T module	Yes
Dewpoint module	Yes
RH and T module with two sensor heads	Yes

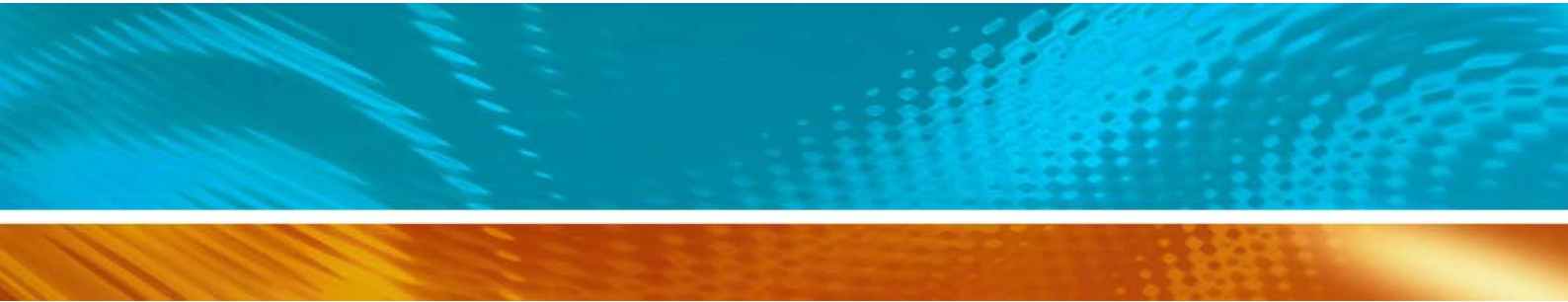

www.vaisala.com

