

OPERATING MANUAL

HMI41 Indicator and HMP42 Probe



© Vaisala Oy 2004

No part of this document may be reproduced in any form or by any means, electronic or mechanical (including photocopying), nor may its contents be communicated to a third party without a prior written notice of the copyright holder.

The instruction manuals may be changed without prior notice.

Contents

1.	THE HMI41 INDICATOR AND PROBES.....	1
2.	TO BE NOTED IN THE MEASUREMENT OF HUMIDITY	3
3.	GETTING STARTED	4
3.1	Inserting the batteries.....	4
3.2	Connecting the HMP42 probe.....	4
3.3	Starting the measurements	4
3.4	Using the HMP42 for measuring equilibrium humidity in structures	5
3.4.1	Example 1: measuring humidity in a bathroom	5
3.4.2	Example 2: measuring humidity in a concrete floor.....	6
3.4.3	Erroneous installations.....	7
4.	HOW TO USE THE HMI41 INDICATOR AND HMP42 PROBE	8
4.1	Turning the indicator on	8
4.2	Measurement readings on display	9
4.3	HOLD-mode	10
4.3.1	MIN-mode	10
4.3.2	MAX-mode.....	10
5.	CALIBRATION	11
5.1	How to use the HMP42 calibration adapter.....	11
5.2	Calibration with trimmer potentiometers	12
5.2.1	Humidity calibration.....	12
5.3	Calibration with HMI41 software commands	14
5.3.1	One point humidity calibration	16
5.3.2	Two point humidity calibration	18
5.3.3	One point temperature calibration	20
5.3.4	Two point temperature calibration	22
6.	HMI41 AND DATA COLLECTING	25
6.1	Entering the data collecting mode	25
6.2	Manual data collecting.....	26
6.3	Setting the measurement duration.....	27
6.4	Setting the measurement interval	27
6.5	Reading the measurement results	28
6.5.1	MIN and MAX in data collecting REC READ mode	30
7.	TRANSFERRING THE STORED READINGS TO A PC	31
7.1	Giving the communication parameters.....	31
7.2	Transferring the data	34
8.	SETUP PROCEDURE	37
8.1	Entering the setup mode	37
8.2	Selecting the display units	38
8.3	Setting the automatic power-off function.....	39

8.4	Selecting the display quantities	39
8.5	Setting the pressure for mixing ratio and wet bulb temperature calculations..	40
8.6	Selecting the probe type	40
9.	MAINTENANCE.....	41
9.1	Changing the filter and the sensor head set	41
9.2	Chemical tolerances of the HUMICAP®MINI sensor.....	41
9.3	Spare parts and accessories.....	42
10.	IN CASE OF ERROR.....	43
10.1	Trouble shooting	43
10.2	Checking the settings	44
11.	TECHNICAL DATA.....	45
11.1	HMI41 indicator.....	45
11.2	HMP42 probe.....	46
11.4	Accuracy of the calculated quantities	48
11.5	Electromagnetic compatibility	51
	APPENDIX 1: QUICK REFERENCE GUIDE.....	52

WARRANTY

This manual is valid for programme versions 2.01 or greater.

1. THE HMI41 INDICATOR AND PROBES

The HMI41 is an easy-to-use portable humidity and temperature indicator for a variety of applications, including such as industrial monitoring and inspections, occupational health and safety, laboratory and research use, spot checking etc. When equipped with optional calibration cables, the HMI41 can also be used as a field calibrator for most Vaisala transmitters.

The HMI41 has as many as six different probe types to choose from. The indicator recognizes the probe type automatically, so there is no need to change settings each time the probe is changed. However, please, note that this feature is active only in indicators and probes with letters ID in the instrument label. For previous versions, the probe type has to be set manually. The HMP44 is an exception, as indicators marked with ID recognize automatically all versions of this probe. All probe types are optimized for different applications:

- HMP41 probe can be used for measuring humidity and temperature in numerous applications, for example in spot checks.
- HMP42 probe head has a diameter of only 4 mm. The HMP42 consists of a handle a 23.5 cm long probe head. This remarkably small and round probe structure is specially indicated for measurements in very tight spaces, e.g. in joint spaces between tiles and in air conditioning channels, as well as for measuring the equilibrium humidity of e.g. timber; the operating temperature range is -40 - +100 °C.
- HMP44 and HMP44L are used for measuring humidity in concrete and other structures.
- HMP45 probe is indicated for measurements in channels and other places that are difficult to reach and therefore require a probe head with cable.
- HMP46 probe is optimized for measurements in relatively high temperatures (up to +100 °C, temporarily even +180 °C), in dirty processes and in general in applications that require a robust probe structure.



The HMI41 indicator displays relative humidity, temperature and dewpoint temperature readings. In addition to these, one of the following quantities can also be chosen: absolute humidity, wet bulb temperature or mixing ratio.

The indicator also features an automatic power-off function which can be disabled, and a continuously updated display. The display can be frozen to show the current readings, and it can be used for checking the minimum and maximum readings measured during data collecting. The automatic power-off function is not active during data collecting even if it was previously selected.

The versatile HMI41 indicator also includes a data collecting feature. Data collecting can be either automatic or manual, and it can be optimized for each application: both the measurement interval and duration can be set by the user. During automatic data collecting, the probe takes measurements only just before storing each measurement. In order to minimize the consumption and to maximize the battery life, the power is automatically turned off for the measurement interval and the display is dim except when the readings on the display are updated (once a minute). The stored readings can be transferred to a PC via a serial interface (order code 19446ZZ) and then printed, if required.

The humidity measurement range is 0 - 100 %RH. The temperature measurement range with the HMP42 probe is -40 - +100 °C. Relative humidity is measured with the accurate and stable HUMICAP®MINI humidity sensor which uses an operating principle based on the changes in the capacitance of the sensor as its thin polymer film absorbs water molecules.

2. TO BE NOTED IN THE MEASUREMENT OF HUMIDITY

In the measurement of humidity and especially in calibration it is essential that temperature equilibrium is reached. Even a small difference in temperature between the measured object and the sensor causes an error. If the temperature is +20 °C (+68 °F) and the relative humidity is 50 %RH, a difference of ± 1 °C between the measured object and the sensor causes an error of ± 3 %RH. When the humidity is 90 %RH, the corresponding error is ± 5.4 %RH.

The error is at its greatest when the sensor is colder or warmer than the surroundings and the humidity is high. Although the humidity sensor reacts rapidly to changes in the amount of water vapour in the air, the probe temperature changes more slowly. To avoid errors caused by temperature differences the probe must always be left to stabilize to ambient temperature before starting measurements: the bigger the temperature difference, the longer the stabilization time.

Indoors relative humidity should be measured in a place where the temperature is as close to the average temperature of the room as possible. Measurements taken close to heat sources will not give a true picture of the relative humidity in the whole room.

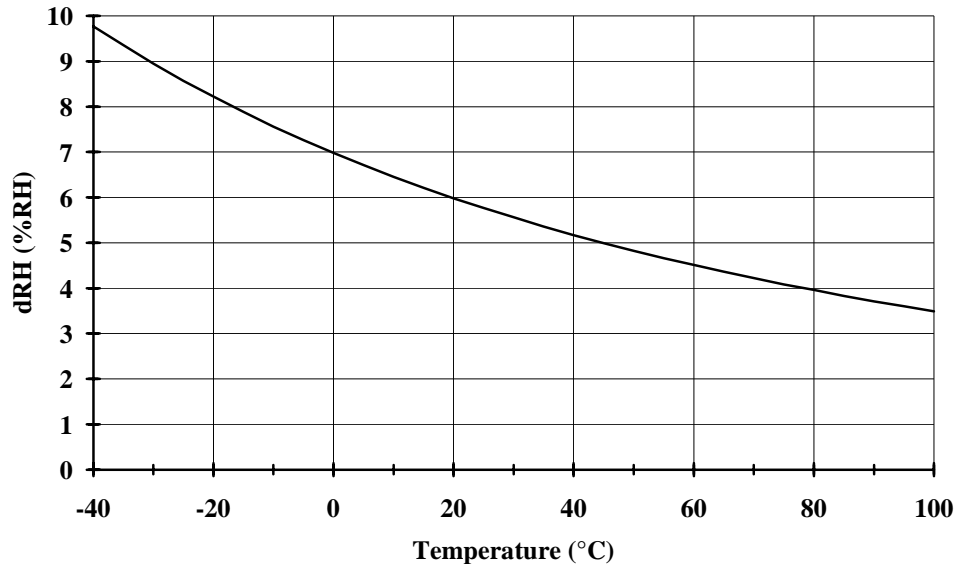

Figure 2.1 Measurement error at 100 %RH when the difference between the ambient and the sensor temperature is 1 °C

3. GETTING STARTED

3.1 Inserting the batteries

When taking the HMI41 indicator into use, first insert the batteries (4 pcs of size AA [LR6] batteries). Open the lid on back of the device and insert the batteries as indicated in the housing. Then close the lid carefully.

3.2 Connecting the HMP42 probe

Connect the HMP42 probe cable to the connector marked 'PROBE' at the bottom of the HMI41 indicator (see Figure 3.2.1).

NOTE

If the indicator does not have letters ID in the instrument label (on the back of the indicator), you must give the probe setting manually before starting the measurements (see Chapter 8).

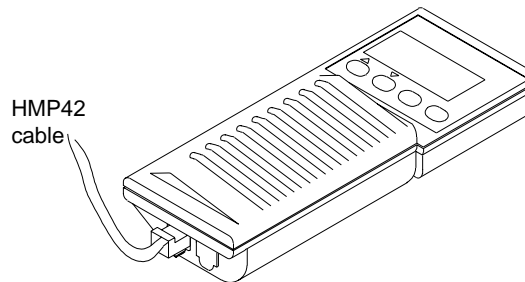
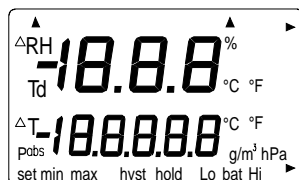

Figure 3.2.1 Connecting the HMP42 probe to the HMI41

3.3 Starting the measurements

Before starting the measurements with the HMP42, remember to allow enough time for stabilization.

Turn the power on with the ON/OFF button and the following appears:



Within a couple of seconds, the display changes to show the software version and the probe type (42.46):



NOTE: if the following appears, check that the probe is correctly connected:

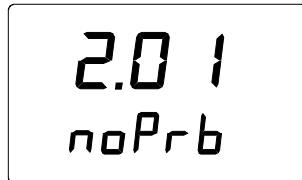

If the software version does not appear, it is smaller than 1.02 and the indicator cannot be used with the HMP42 probe. If the probe type does not appear, the indicator is of a previous version and does not recognize the probe type automatically; give the setting manually (see Chapter 8).

In a couple of seconds, the battery charge appears and after that, the first measurement readings:

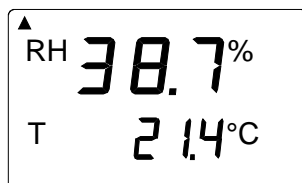

More detailed instructions of use are given in Chapter 4.

3.4 Using the HMP42 for measuring equilibrium humidity in structures

The HMP42 has been optimized for taking measurements in structures and tight places. The following photos illustrate some examples of use in these applications.

3.4.1 Example 1: measuring humidity in a bathroom

In this example, the screw of the shower holder is removed; no drilling is needed as the HMP42 is small enough to enter this screw hole.

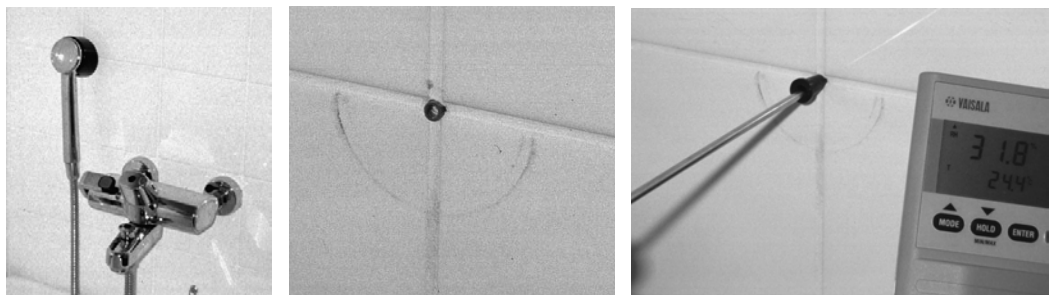
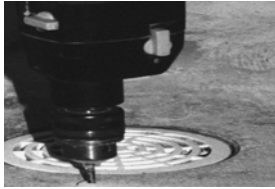

Figure 3.4.1 Taking measurements in a bathroom

3.4.2 Example 2: measuring humidity in a concrete floor

Bore a hole and clean it thoroughly so that all drilling dust comes out; blowing air is a good method for cleaning. However, please, note that if you clean several holes, you should use a mask to protect yourself against dust. You can also use a vacuum cleaner. Seal the hole e.g. with tape. Let stabilize (e.g. 24 hours in concrete). Cut the tape, insert the probe in the hole and take measurements. See photos below for steps 1 - 6.

1. Bore a hole.



2. Clean it.



3. Seal it and let stabilize.



4. Cut the tape.



5. Insert the probe.



6. Take measurements.



Figure 3.4.2 Taking measurements in concrete floors

3.4.3 Erroneous installations

Please, note that although with a metal probe head, the HMP42 is a delicate instrument and requires careful handling. The probe must never be strongly bent or forced through anything; if necessary, use e.g. a sharp edged pin with a diameter of 5 mm. The filter must not be twisted. When taking measurements in structures, never leave the cable and indicator hanging down while leaving the probe to stabilize (see photos below). Make sure that when mounted horizontally, the probe is at least 4 cm inside the structure in order to avoid bending. See the following photos and make sure that your installation is not like the one on the right.

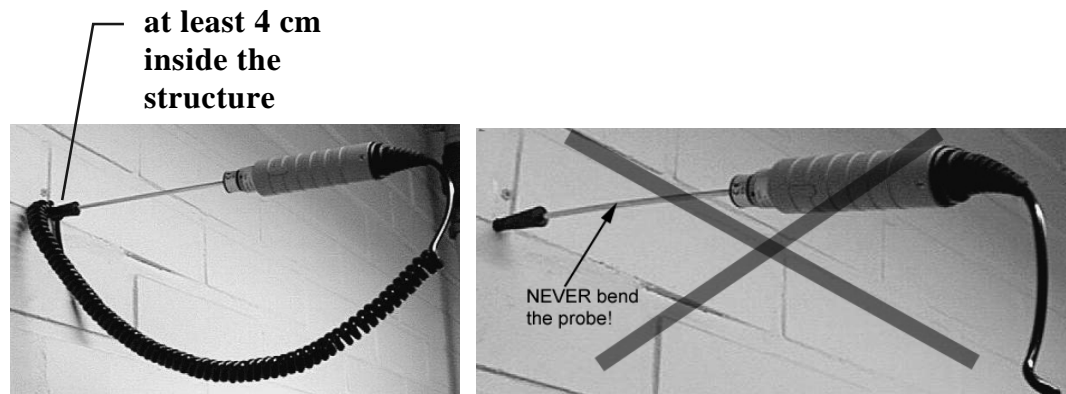
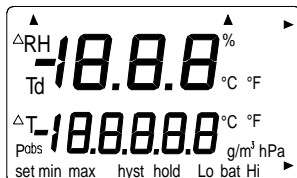

Figure 3.4.3 Installation: correct way on the left, erroneous on the right

4. HOW TO USE THE HMI41 INDICATOR AND HMP42 PROBE

4.1 Turning the indicator on

To start the measurements with the HMI41, just press the ON/OFF button and the following text appears:



After a few seconds, the software version and probe type indication appear:



If the software version does not appear, it is smaller than 1.02 and the HMI41 cannot be used with the HMP42. Contact Vaisala or a Vaisala representative for further information.

Make sure that you can see the text 42.46 on the display. If not, the indicator is of a previous version and does not recognize the probe type automatically. Give the probe type setting manually (see Chapter 8).

After a couple of seconds, the battery voltage appears on the display with an indication of the battery charge (high or low):

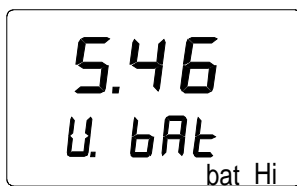

If the battery voltage is higher than 4.75 V, the text on the lower righthand corner is “bat HI” and after a few seconds, the HMI41 automatically displays the RH and T readings. If the voltage is 4.65...4.75 V, the text is “Lo bat” and the batteries should be replaced (see Chapter 3.1). If the voltage is lower than 4.65 V, the indicator turns itself off to prevent erroneous measurements and readings. Should this happen, replace the batteries.

4.2 Measurement readings on display

Relative humidity and temperature readings appear automatically after the battery charge indication:

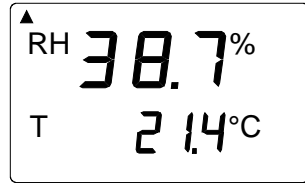

If MODE button is pressed, **dewpoint temperature** (Td) reading is displayed:



When the MODE button is pressed again, one of the following is displayed or the HMI41 returns to showing the RH and T readings according to what has been chosen for the measurement quantities (see Chapter 4.4):



Temperature and **absolute humidity**

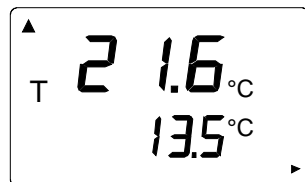

Temperature and **wet bulb temperature**; the arrow in the lower righthand corner indicates that wet bulb temperature has been chosen

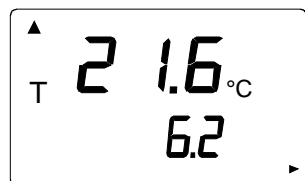

Temperature and **mixing ratio**; the arrow in the lower righthand corner indicates that mixing ratio has been chosen (the unit is g/kg or gr/lb).

4.3 HOLD-mode

In any of the previously mentioned measurement reading displays, the HOLD button freezes the display to show the current readings, e.g. RH & T readings:

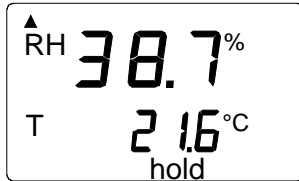

With MODE or ENTER, the display returns to the normal display mode.

If the indicator turns itself off with the automatic power-off function during the HOLD-mode, it wakes up in the same mode when turned on again. The 'hold'-text is blinking and the indicator can be returned to the normal display mode with any button except ON/OFF.

4.3.1 MIN-mode

If you wish to know the minimum readings that have been measured after power up, press HOLD when the indicator is in the HOLD-mode. The minimum readings of the currently displayed quantities are shown (if the 'hold'-text is blinking, the HMI41 must first be returned to the normal display mode in order to activate the MIN-mode; see Chapter 4.3 above):

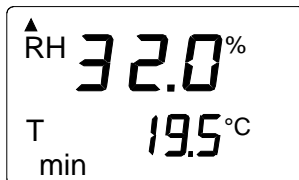

With MODE or ENTER, the indicator returns to the normal display mode.

4.3.2 MAX-mode

If you wish to know the maximum readings that have been measured after power up, press HOLD when the indicator is in the MIN-mode. The maximum readings of the currently displayed quantities are shown:

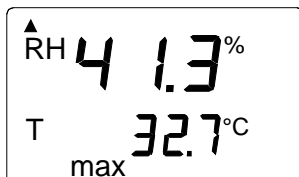

The indicator returns to the normal display mode with any button except ON/OFF.

5. CALIBRATION

5.1 How to use the HMP42 calibration adapter

As the HMP42 probe diameter is extremely small, the probe has a special calibration adapter for inserting the probe into a salt chamber (e.g. in the HMK15 calibrator).

NOTE

Be extremely careful when inserting the probe into the calibration adapter: do not bend or break it.

The probe is inserted into the adapter **with the steel grid on**; this protects the sensor and prevents it from breaking. Unlike other humidity probes, the HMP42 is calibrated **with the steel grid on** and thus, the probe naturally requires a slightly longer stabilization time (approx. 30 minutes).

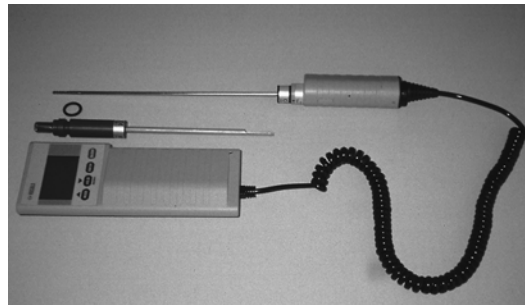

Figure 5.1.1 HMI41, HMP42 and calibration accessories

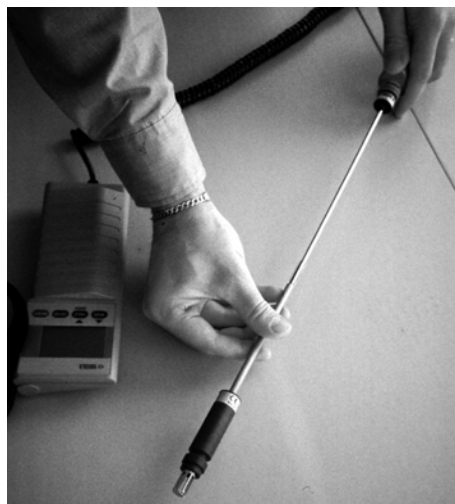

Figure 5.1.2 Insert the probe head into the calibration adapter

5.2 Calibration with trimmer potentiometers

5.2.1 Humidity calibration

The HMI41 indicator and HMP42 probes are fully calibrated at the factory so there should be no immediate need for re-calibration. The recommended calibration interval is one year. However, calibration should be performed always when there is a reason to believe that the adjustments have changed.

Humidity calibration of the HMP42 probe is done by adjusting trimmer potentiometers. The potentiometers are located under a protective plug. The potentiometer marked T (temperature) is for factory use only; DO NOT make any adjustments. To make sure that this potentiometer is not accidentally touched when adjusting the other two, turn the plastic plug aside without removing it completely (see Figure 5.2.1).

For adjusting the potentiometers, use a trimming wrench provided with the probe, or some other suitable tool, e.g. a ceramic 1.5 mm slot screwdriver.

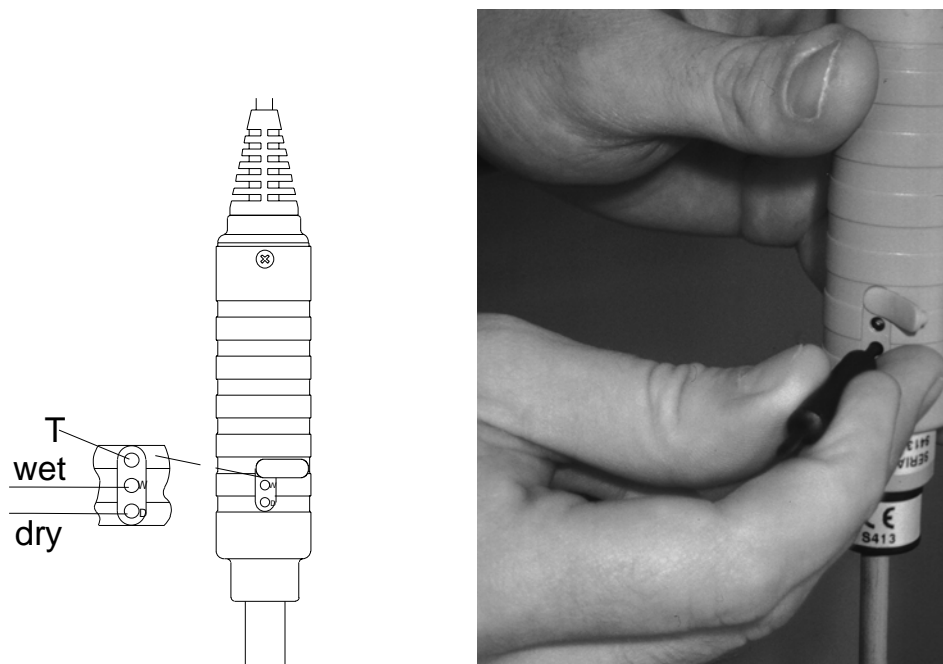

Figure 5.2.1 Adjusting the trimmer potentiometers

A two point calibration is performed with the HMK15. Calibrator or the probe can be sent to Vaisala. The probes must always be re-calibrated if the sensor head set is changed.

The calibration procedure is as follows (see also the calibrator manual):

- Leave the calibrator and the probe at the calibration site for at least 30 minutes before starting the calibration in order to let the probe temperature stabilize to the room temperature.
- Insert the probe into a measurement hole of the LiCl salt chamber (see Figure 5.2.2).



Figure 5.2.2 The HMP42 in a salt chamber of the HMK15 calibrator

- Wait until the humidity reading stabilizes (approx. 30 minutes). Check the temperature and read the closest humidity value in the calibration table. Adjust the dry end reading with the potentiometer D (dry) in the probe body to correspond to the value given in the calibration table; use a suitable trimming screw wrench (see Figure 5.2.1).
- Insert the thermometer into the 13.5 mm hole of the NaCl salt chamber and the probe into another hole of the NaCl chamber.

NOTE

When calibrating probes that are being used for long term measurements (over 1 hour) in high humidities (90 - 100 %RH), use the K_2SO_4 salt as the high end reference.

- Wait until the humidity reading stabilizes. Read the salt chamber temperature from the thermometer and then the closest humidity value from the calibration table. Adjust the wet end reading with the potentiometer W (wet) to correspond to the value given in the calibration table.

Table 5.2 Greenspan's calibration table

°C	LiCl	NaCl	K ₂ SO ₄
0	*	75.5	98.8
5	*	75.7	98.5
10	*	75.7	98.2
15	*	75.6	97.9
20	11.3	75.5	97.6
25	11.3	75.3	97.3
30	11.3	75.1	97.0
35	11.3	74.9	96.7
40	11.2	74.7	96.4
45	11.2	74.5	96.1
50	11.1	74.4	95.8

* If the LiCl solution is used or stored in temperatures below +18°C, its equilibrium humidity changes permanently

As the D (dry) and W (wet) adjustments may affect each other, check again the humidity reading in the LiCl salt chamber: insert the probe into the calibration hole and wait until the reading stabilizes. If necessary, repeat the adjustments in both the LiCl and the NaCl (K₂SO₄) salt chambers until the reading is correct.

5.3 Calibration with HMI41 software commands

Calibration can also be done with the HMI41 software commands by entering the corrections in the indicator memory with pushbuttons. If only one probe is being used, the HMI41 software calibration is useful. However, when several probes are in use, it is recommended that calibration is done by adjusting the probe potentiometers. Note that when the sensor head set is changed, calibration must always be done by adjusting the potentiometers and it is recommended that the HMI41 is reverted to factory settings by selecting default calibration.

NOTE

If the factory calibration of the HMI41 is changed, the correction data refers to the calibrated probe only. Therefore, if you change the probe, always revert this data to factory settings by selecting default calibration, or perform a new calibration with the new probe.

The calibration procedure is included in the HMI41 setup mode. For entering the setup mode, first press the ON/OFF button and the following appears:

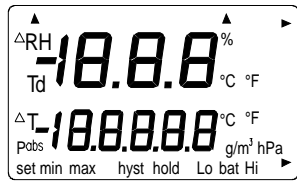

Then release the ON/OFF button and press within 1...2 seconds both ENTER and MODE buttons until the following text appears on the display:



After a few seconds, the text changes automatically to show the following:

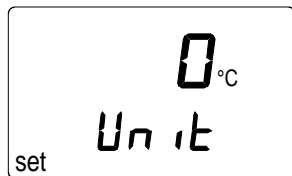

Press ENTER eight times until the following text appears:

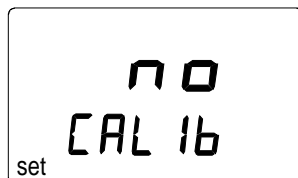

This indicates that no calibration has been selected. In addition to this, there are five calibration types available. The desired type is selected with buttons ▲ or ▼.

All selections are acknowledged with ENTER. In the following, you will find a list of these calibration options.

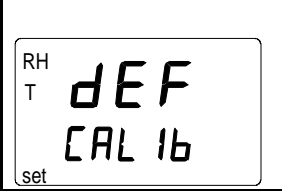
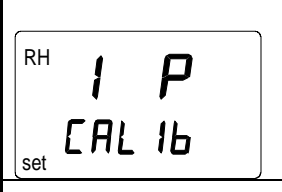
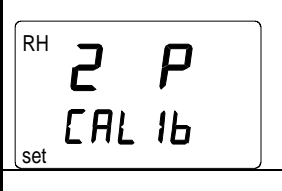
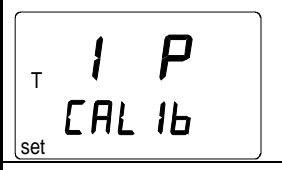
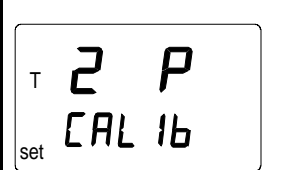
	<p>Default calibration restores the factory settings of the humidity and temperature calibrations.</p>
	<p>One point humidity calibration; select this for performing humidity calibration at one point. See Chapter 5.3.1 for further details.</p>
	<p>Two point humidity calibration; select this for performing humidity calibration at two points. See Chapter 5.3.2 for further details.</p>
	<p>One point temperature calibration; select this for performing temperature calibration at one point. See Chapter 5.3.3 for further details.</p>
	<p>Two point temperature calibration; select this for performing temperature calibration at two points. See Chapter 5.3.4 for further details.</p>

5.3.1 One point humidity calibration

In one point humidity calibration, one accurate humidity reference is sufficient. However, note that after one point calibration, the humidity reading is most accurate near the reference value. For a better accuracy over the whole range, perform a two point calibration if possible.

Leave the reference instrument (HMK15) and the probe at the calibration site at least 30 minutes so that the probe temperature stabilizes to the room temperature. Start the calibration by inserting the probe to the reference humidity.

In setup mode, press ENTER repeatedly until the following is displayed:

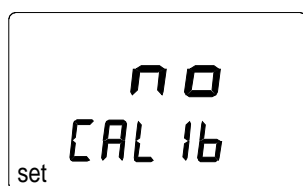

Then press MODE twice, and the following appears:

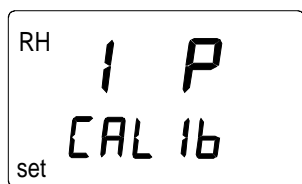

Press ENTER to activate the one point calibration mode. A message similar to the following appears with the first line blinking:

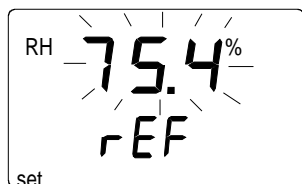

The blinking number indicates the humidity reference value in the HMI41 memory. Check the salt chamber temperature, read the closest humidity value in the calibration table and adjust the display with buttons ▲ and ▼ to correspond to the value given in the table. For example, if the temperature in the calibrator's NaCl salt chamber is 20.5 °C, adjust the value to 75.5 %RH:

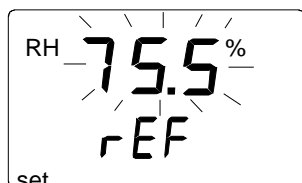

Each time the button is pressed, the value changes with 0.1 %. If you keep the button pressed, the value changes in a faster mode. Press ENTER and the HMI41 indicator shows the value that the probe is currently measuring, displaying a message similar to the following:

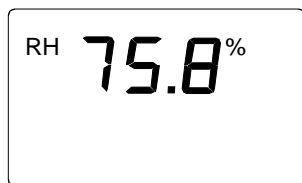

Wait at least ten minutes for the reading to stabilize and press ENTER to acknowledge the value. Press ENTER again to conclude the one point calibration. If the calibration has been successful, the following message appears:



The correction data has now been calculated and stored in the HMI41 memory. The HMI41 returns automatically to the selection of display units, and can be turned off. When the indicator is used as a standard indicator and the correction data differs from the factory settings, an arrow in the upper righthand corner is displayed:

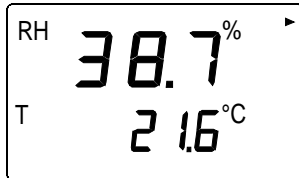

If the message “*cal pass*” does not appear (instead, some other text may appear, e.g. “*too close*”, “*err offst*” or “*err gain*”), the correction has not been stored in the memory. The error may be due to an incorrect reference value or to measured values that are out of the range.

5.3.2 Two point humidity calibration

In two point humidity calibration, two accurate references (e.g. the HMK15 Calibrator) are needed. Leave the reference instrument and the probe at the calibration site for at least 30 minutes so that the probe temperature stabilizes to the room temperature.

Start the calibration by inserting the probe to the lower reference humidity. In setup mode press ENTER repeatedly until the following is displayed:



Then press MODE three times, and the following appears:

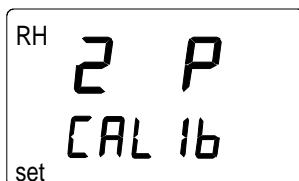

Press ENTER to activate the two point humidity calibration mode. A message similar to the following appears with the first line blinking:

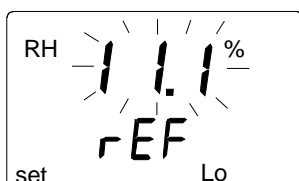

The blinking number indicates the value of the lower humidity reference stored in the HMI41 memory. Check the salt chamber temperature, read the closest humidity value in the calibration table and adjust the display with buttons ▲ and ▼ to correspond to the value given in the table. For example, if the temperature of the LiCl salt chamber is 22 °C, adjust the value to 11.3 %RH:

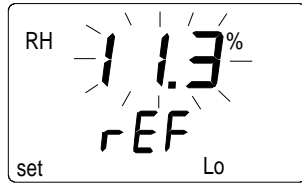

Press ENTER, and the HMI41 shows the value that the probe is currently measuring, displaying a message similar to the following:

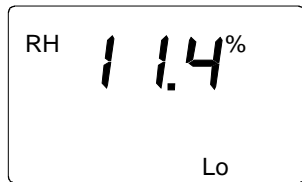

Wait at least ten minutes for the reading to stabilize and press ENTER to acknowledge the value. Press ENTER again to conclude the lower point calibration. A message similar to the following appears with the first line blinking:

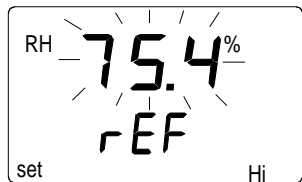

The blinking number indicates the value of the higher humidity reference stored in the HMI41 memory. Insert the probe to the higher reference humidity. Check the salt chamber temperature, read the closest humidity value in the calibration table and adjust the display with buttons ▲ and ▼ to correspond to the value given in the table. For example, if the temperature in the calibrator's NaCl salt chamber is 20.5 °C, adjust the value to 75.5 %RH:

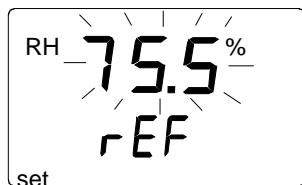

Press ENTER and the HMI41 indicator shows the value that the probe is currently measuring, displaying a message similar to the following:



Wait at least ten minutes for the reading to stabilize and press ENTER to acknowledge the value. Press ENTER again to conclude the calibration. If the calibration has been successful, the following message appears:



The correction data has now been calculated and stored in the HMI41 memory. The HMI41 returns automatically to the selection of the display units, and can be turned off. When the indicator is used as a standard indicator and the correction data differs from the factory settings, an arrow in the upper righthand corner is displayed:

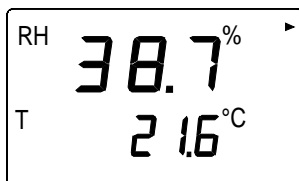

If the message “*cal pass*” does not appear (instead, some other text may appear, e.g. “*too close*”, “*err offst*” or “*err gain*”), the correction has not been stored in the memory. The error may be due to an incorrect reference value or to measured values that are out of the range.

5.3.3 One point temperature calibration

In one point temperature calibration, one accurate temperature reference is sufficient.

Start the calibration by inserting the probe to the reference temperature. In setup mode, press ENTER repeatedly until the following is displayed:

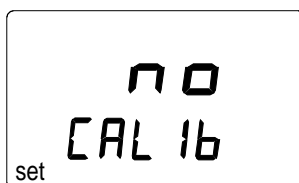

Then press MODE four times, and the following appears:

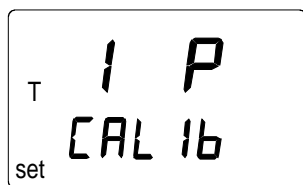

Press ENTER to activate the one point temperature calibration mode. A message similar to the following appears with the first line blinking:



The blinking number indicates the temperature reference value stored in the HMI41 memory. Check the actual temperature reference and change the display with buttons ▲ and ▼ to correspond to the accurate value, for example:

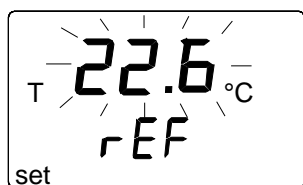

Press ENTER and the HMI41 indicator shows the value that the probe is currently measuring, displaying a message similar to the following:

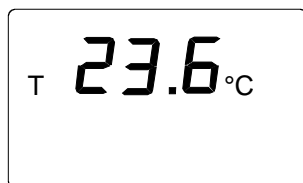

Wait at least ten minutes for the reading to stabilize and press ENTER to acknowledge the value. Press ENTER again to conclude the calibration. If the calibration has been successful, the following message appears:



The correction data has now been calculated and stored in the HMI41 memory. The HMI41 returns automatically to the selection of the display units, and can be turned off. When the indicator is used as a standard indicator and the correction data differs from the factory settings, an arrow in the upper righthand corner is displayed:

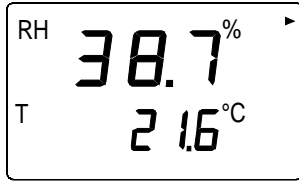

If the message “*cal pass*” does not appear (instead, some other text may appear, e.g. “*too close*”, “*err offst*” or “*err gain*”), the correction has not been stored in the memory. The error may be due to an incorrect reference value or to measured values that are out of the range.

5.3.4 Two point temperature calibration

In two point temperature calibration, two accurate temperature references are needed. Note that you must allow enough time for all instruments to stabilize to the temperature equilibrium.

Start the calibration by inserting the probe to the lower reference temperature. In setup mode, press ENTER repeatedly until the following is displayed:

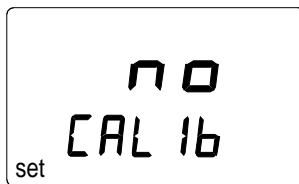

Then press MODE five times, and the following appears:

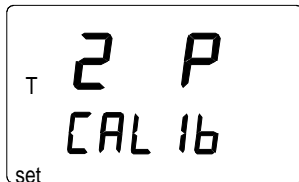

Press ENTER to activate the two point temperature calibration mode. A message similar to the following appears with the first line blinking:

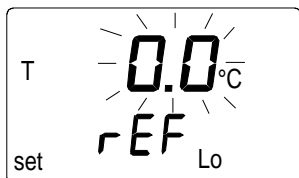

The blinking number indicates the value of the lower temperature reference stored in the HMI41 memory. Insert the probe to the lower reference temperature. Check the reference temperature and change the display with buttons ▲ and ▼ to correspond to the accurate value, for example:

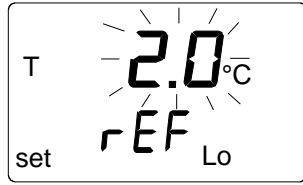

Press ENTER and the HMI41 shows the value that the probe is currently measuring, displaying a message similar to the following:



Wait at least ten minutes for the reading to stabilize and press ENTER to acknowledge the value. Press ENTER again to conclude the lower point calibration. A message similar to the following appears with the first line blinking:

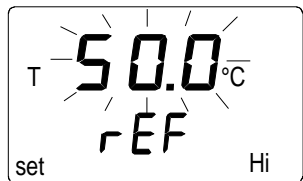

The blinking number indicates the value of the higher temperature reference stored in the HMI41 memory. Insert the probe to the higher reference temperature. Check the reference temperature and change the display with buttons ▲ and ▼ to correspond to the accurate value, for example:

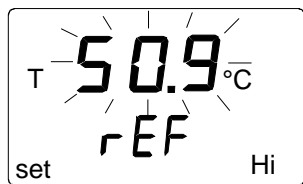

Press ENTER and the HMI41 shows the value that the probe is currently measuring, displaying a message similar to the following:

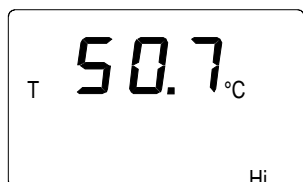

Wait at least ten minutes for the reading to stabilize and press ENTER to acknowledge the value. Press ENTER again to conclude the calibration. If the calibration has been successful, the following message appears:



The correction data has now been calculated and stored in the HMI41 memory. The HMI41 returns automatically to the selection of the display units, and can be turned off. When the indicator is used as a standard indicator and the correction data differs from the factory settings, an arrow in the upper righthand corner is displayed:

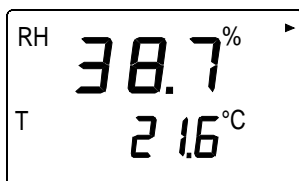

If the message “*cal pass*” does not appear (instead, some other text may appear, e.g. “*too close*”, “*err offst*” or “*err gain*”), the correction has not been stored in the memory. The error may be due to an incorrect reference value or to measured values that are out of the range.

6. HMI41 AND DATA COLLECTING

The HMI41 indicator can also be used for collecting the measurement data. The data is stored in the indicator's non-volatile memory which means that it is not lost when the indicator is turned off. Please, note also that the automatic power-off function is not active during data collecting even if previously selected (see Chapter 8.3). When the data collecting has ended, the automatic power-off function becomes active again.

6.1 Entering the data collecting mode

To enter the data collecting mode, turn the indicator on with the ON/OFF button and the following appears for a couple of seconds:

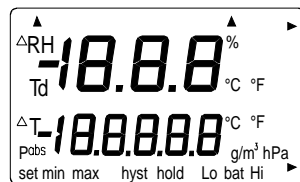

Release the ON/OFF button and press immediately the button HOLD. The software version and the probe type indication appear, after which the display changes automatically to show the battery charge:

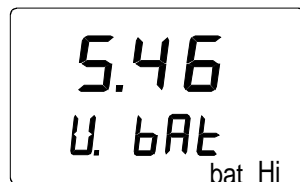

Within a couple of seconds the text REC AUTO appears on the display; release the HOLD button.



This is the main display of the data collecting mode. With the button MODE you can enter the REC CATCH mode (manual data collecting, see Chapter 6.2) and by pressing MODE again, the REC READ mode (reading the measurement results, see Chapter 6.5). By pressing ENTER, you can set the measurement duration and by pressing ENTER again, the measurement interval (Chapters 6.3 and 6.4). By pressing HOLD, you can always return to the previous display.

6.2 Manual data collecting



For manual data collecting, press the button MODE and the following appears:



Press ENTER and a text similar to the following appears:

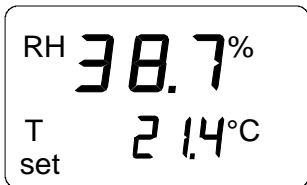

The probe is now taking measurements and you can store the readings at appropriate intervals by pressing the button HOLD. The sequence number of the reading in the indicator memory appears for a couple of seconds:



The indicator returns automatically to show the readings. You can store 199 measurement readings in the indicator memory (numbers 1 - 199). In automatic data collecting, you can store 200 readings (0 - 199). Data collecting is ended by turning the indicator off. The readings can be read in the REC READ mode (see Chapter 6.5).

6.3 Setting the measurement duration

Turn the indicator on with the ON/OFF button, press immediately the button HOLD and keep it pressed until the text REC AUTO appears on the display. Press ENTER and a text similar to the following on the display:



(previously set duration)

In this mode, you can set the time between the first and the last measurement stored, e.g. 30 minutes or 3 days. When entering this mode, previously set duration time appears on the display. If the previously set duration time is too long for the current battery charge, the longest calculated duration time possible for this battery charge appears instead. This is also indicated with the text 'MAX'. The duration of the measurement can be set from 15 minutes to 7 days. The batteries last for 7 days during data collecting provided that they are of the same type as those delivered with the indicator.

Set the duration with buttons ▲ and ▼. The duration time can be selected in steps according to the following:

- 15 min; 30 min
- 1 - 6 h: each pressing = 1 h
- 12 h
- 1 - 7 d: each pressing = 1 d

If the duration selected is too long for the current battery charge, the text 'BAT' appears. Select a shorter duration time.

By pressing ENTER, the indicator goes on to the setting of the measurement interval.

6.4 Setting the measurement interval

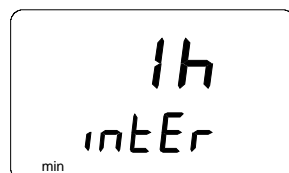

(previously set interval)

In this mode, you can set the time that you wish to pass between two measurements being stored, e.g. 5 minutes or 2 hours. When entering this mode, previously set interval appears on the display. If the previously set measurement interval is too short for the current memory capacity of the indicator, the shortest calculated measurement interval appears instead. This is also indicated with the text 'MIN'.

Select the interval with buttons ▲ and ▼. The measurement interval can be selected in steps according to the following:

- 1 - 5 min: each pressing = 1 minute
- 10 min; 15 min; 30 min
- 1 - 6 h: each pressing = 1 hour
- 12 h

The text 'LO' on the display indicates that there is not enough memory for the chosen interval; select a longer interval. By pressing ENTER, a text similar to the following appears:

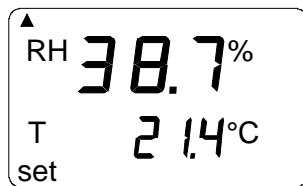

This is the measurement mode with the data collecting feature activated. It can be distinguished from the normal measurement mode by the text 'SET' on the lower lefthand corner of the display. The readings on the display are updated once a minute, and **the display is dim except during this updating** in order to minimize the consumption. If the indicator is turned off, the measurements stored so far remain in the memory and they can be read by turning the indicator on in the REC READ mode (see section 6.5).

You can end data collecting by pressing ON/OFF.

6.5 Reading the measurement results

The measurement results can be read in the REC READ mode. This mode can be entered from the REC AUTO mode by pressing twice the button MODE. The following appears:



Press ENTER, and a text similar to the following appears on the display:

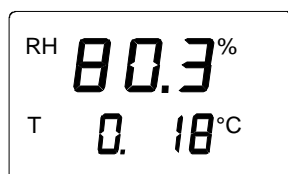

Numbers on the first line indicate the reading of the quantity in question (in this example, RH). The number on the left of the second line (in this example

number 0.) is the sequence number of the measurement. This number helps to estimate the time of the measurement during automatic data collecting provided that the starting time and the measurement interval are known. Numbers located on the right on the second line indicate the temperature reading measured simultaneously with the reading on the first line; if you wish to see the decimals, press ENTER. The reading appears on the display with one decimal:

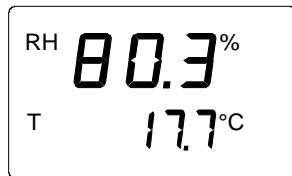

In a couple of minutes the indicator returns to the previous display.

By pressing MODE, you can change the quantity on the first line:



By pressing ENTER (with any quantity on the first line), an arrow appears on the upper righthand corner of the display:

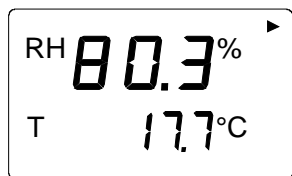

By pressing HOLD while the arrow is displayed, you can scroll the measurement results (note that the sequence number changes):

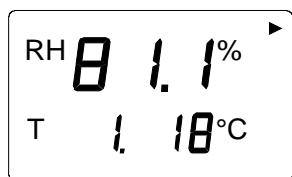

HOLD:

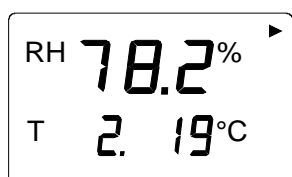

etc.

If the buttons are pressed continuously, numbers change in a faster rate.

6.5.1 MIN and MAX in data collecting REC READ mode

When the data collecting REC READ mode has been activated, the HOLD button brings four different modes on the display: MIN HI, MAX HI, MIN LO and MAX LO. These modes indicate the maximum and minimum readings measured for the quantities on the display. HI and LO tell you whether the reading observed is the one on the first line (HI) or the one on the second line (LO). MIN and MAX indicate whether the reading on the display is the minimum or the maximum value. In other words, if the text is MIN HI it means that you are now observing the minimum reading of the quantity on the first line.

By pressing HOLD repeatedly you can change from one display mode to another, and by pressing MODE you can change the quantity on the first line. In all these modes, the decimals of the second line reading are shown by keeping the button ENTER pressed down.

Examples:

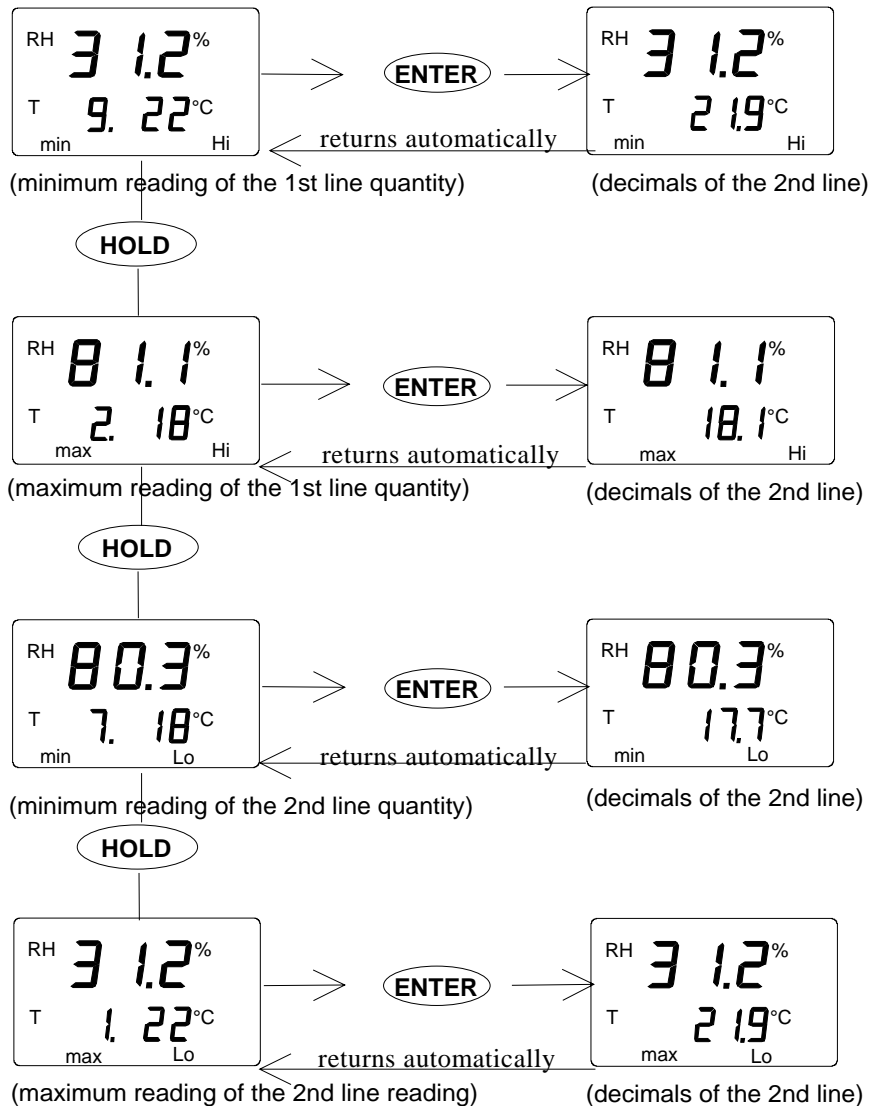

7. TRANSFERRING THE STORED READINGS TO A PC

The readings that have been stored in the HMI41 memory manually or automatically in the data collecting mode, can be transferred to a computer and then printed if desired. In order to do this, connect a serial connection cable (order code 19446ZZ) to the appropriate connectors:

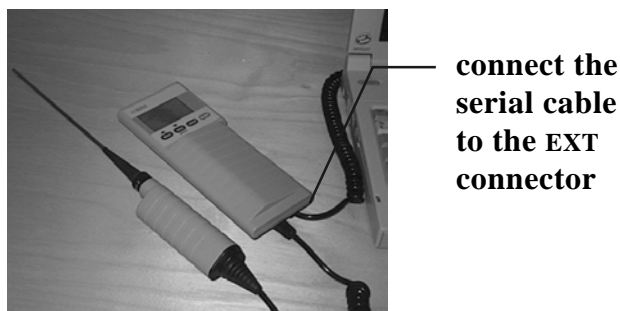

Figure 7.1 Connecting the cable

7.1 Giving the communication parameters

Give the communication parameters when using this terminal session for the first time; save them for future use. See instructions in the following tables.

Table 7.1.1 Giving parameters in Windows 3.1

MENU	DESCRIPTION
PROGRAM MANAGER	
↓	
ACCESSORIES	double click
↓	
TERMINAL	double click
↓	
Settings	click
↓	
Communications	click and give parameters (see figure 7.1.1 next page); click OK
↓	
File	
↓	
Save as	click and save settings: type the name of the file (e.g. HMI41) and click OK
Turn the HMI41 on and follow the instructions in Ch. 7.2	

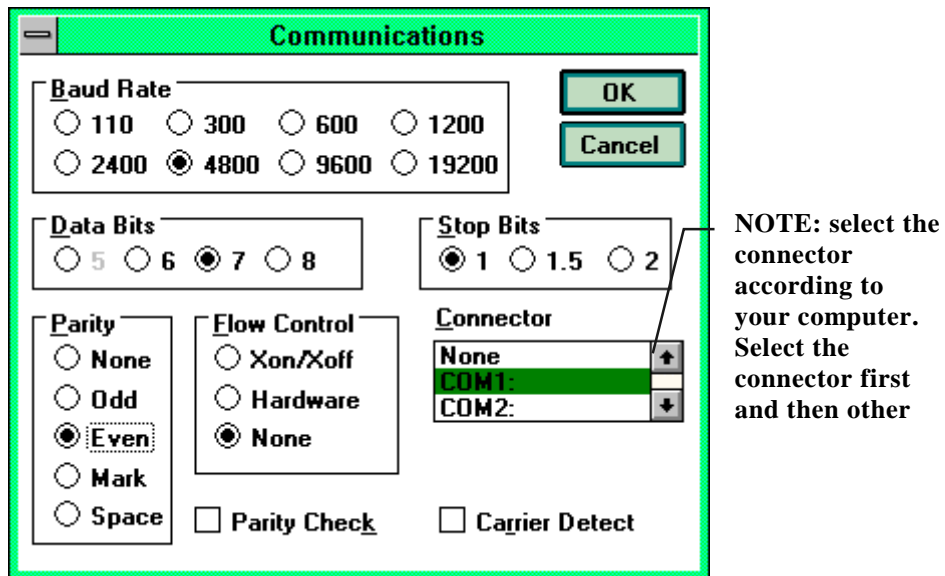

Figure 7.1.1 Giving the communication parameters in Windows 3.1

Table 7.1.2 Giving parameters in Windows 95 and Windows NT

WINDOWS 95		WINDOWS NT	
MENU	WHAT TO DO	MENU	WHAT TO DO
Start		Start	
↓	move the cursor to:	↓	move the cursor to:
Programs		Programs	
↓	move the cursor to:	↓	move the cursor to:
Accessories		Accessories	
↓	move the cursor to:	↓	move the cursor to:
HyperTerminal	click	HyperTerminal	
↓	move the cursor to:	↓	move the cursor to:
Hypertrm	double click	Hyperterminal	click
↓		↓	
Connection Description	type the name of the connection (e.g. HMI41) in the appropriate field and select an icon if available; click OK.	Connection Description	type the name of the connection (e.g. HMI41) in the appropriate field and select an icon if available; click OK.
↓			
Phone Number	move the cursor to the field CONNECT USING and select 'direct to COM x' (x = serial port available); click OK	Connect to	move the cursor to the field CONNECT USING and select 'COM x' (x = serial port available); click OK
↓		↓	
COM x properties	select parameters according to the screen in figure 7.1.2; click OK	COM x properties	select parameters according to the screen in figure 7.1.2; click OK
Turn the HMI41 on and follow the instructions in Chapter 7.2			

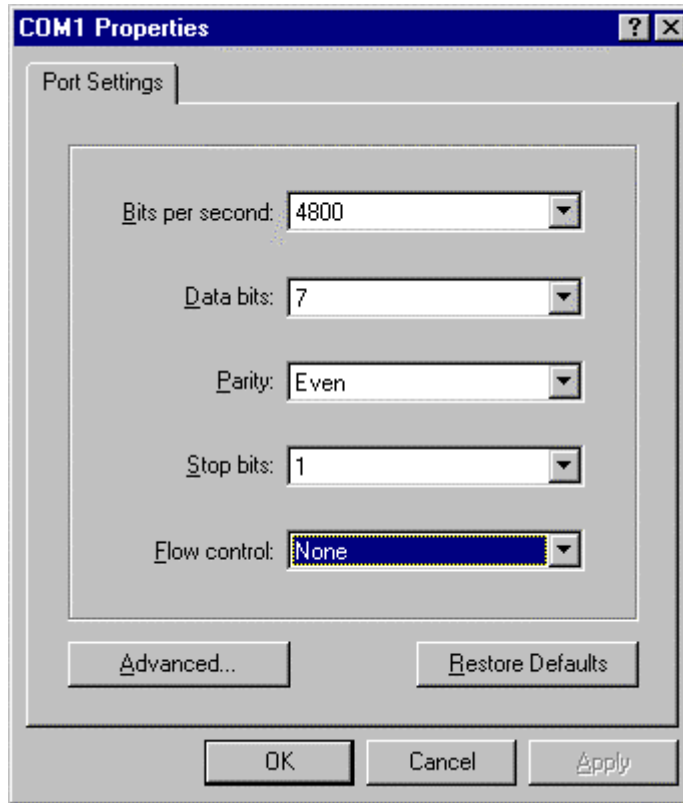

Figure 7.1.2 Selecting the parameters in Windows 95 and NT

7.2 Transferring the data

When you have given the communication parameters, you can start transferring the data from the HMI41. Store the parameters for future use.

To start transferring the data, make sure that the HMI41 is connected to a serial port of your computer and that the terminal session is open. Turn the HMI41 on and a text similar to the following appears:

```
HMI41 / 2.01
>
```

7.2.1 PLAY Transferring the data

To transfer the data on your PC, type **PLAY** and press **ENTER**; an example of outputting automatically collected data:

```
>play
Reading Log... OK
```

data	hh:mm:ss	RH	T	Td
0	00:00:00	12.54	21.53	-8.48
1	00:01:00	12.10	21.23	-9.16
2	00:02:00	12.18	21.18	-9.12
3	00:03:00	12.12	21.15	-9.21
4	00:04:00	12.16	21.14	-9.18
5	00:05:00	12.09	21.12	-9.27
6	00:06:00	12.09	21.09	-9.28

```
>
```

An example of outputting manually collected data:

```
>play
Reading Log... OK

data      RH      T      Td
  1      12.54   21.53  -8.48
  2      12.10   21.23  -9.16
  3      12.18   21.18  -9.12
  4      12.12   21.15  -9.21
  5      12.16   21.14  -9.18
  6      12.09   21.12  -9.27
  7      12.09   21.09  -9.28
>
```

If you know the starting time of the automatic data collecting, you can enter it with the command and get an output showing the actual time of measurement. For example:

```
>play 15:05
Reading Log... OK

data      hh:mm:ss      RH      T      Td
  0      15:05:00      8.52   23.69  -11.70
  1      15:06:00      9.58   23.66  -10.26
  2      15:07:00      9.60   23.50  -10.35
  3      15:08:00      9.61   23.30  -10.48
  4      15:09:00      9.65   23.25  -10.47
  5      15:10:00     11.22   23.41   -8.44
  6      15:11:00      9.93   23.30  -10.08
  7      15:12:00      9.92   23.22  -10.15
>
```

7.2.2 CPLAY Setting characters between decimals and fields

With the CPLAY command, you can select what you want to appear between decimals and various fields. An example:

```
>cplay
Desimal separator : .
Field separator   : TAB

example:
  1      01:00:00      38.72   21.61   7.01
>
```

To change the output, type CPLAY, then the character you wish to appear between decimals, then the character you wish to use between fields and then <cr>. An example:

```
>cplay ,      <cr>

Desimal separator : ,
Field separator   : TAB

example:
  1      01:00:00      38,72   21,61   7,01
>
```

7.2.3 HELP Outputting all available commands and their contents

If you wish to see which commands are available, type HELP and press ENTER. The following list appears:

```
>help
Available commands :
HELP      ?          PLAY      CPLAY
Type HELP <command_name> for more help
>
```

To see the contents of each command, type HELP, command name (e.g. PLAY) and press ENTER; this brings an explanation of the command and its usage on the display:

```
>help play

Command : PLAY
Purpose : Send recordings from memory to serial port
Usage   : PLAY hh:mm <cr>, hh:mm = rec starting time (optional)

if command is used without parameters it uses default setting
>
```

7.3.4 ? Outputting the HMI41 settings

If you need to know which parameters and settings are currently stored in your HMI41 indicator, type ? and press ENTER:

```
>?

HMI41 / 2.01
Serial number : A0000000
Output units  : metric
Baud P D S   : 4800 E 7 1 FDX
Pressure     : 1013.25
Auto Off     : 5
Probe        : 2
Start-up mode : 1
4.th variable : none
>
```

To exit the terminal session, move the cursor to FILE menu and select EXIT. Confirm that you wish to quit and then select whether you wish to store the parameters of this session for future use or not (SAVE - YES/NO).

8. SETUP PROCEDURE

The indicator settings can be changed in the SETUP mode. Note that manual setup procedure is necessary if some of the factory settings have to be changed and if the indicator or the probe does not have letters ID in the instrument label.

The factory settings of the HMI41 are the following:

- display units: **0** (metric)
- automatic power-off: **5** minutes
- display quantities: **0** (= RH, T, Td)
- pressure: **1013.25 hPa** (1 hPa = 1 mbar)
(for wet bulb temperature and mixing ratio calculations)
- probe type **AUT** (or **1**, see below)
- start **1**

Indicators marked with letters ID have the automatic probe recognition as default (AUT PROBE) and previous versions the probe type 1. **If the indicator does not recognize the probe type automatically, set the type manually to 2 when using the HMP42.** Note also that the HMP42 probe cannot be used with the HMI41 unless the software version is **1.02** or greater. To check the version, turn the HMI41 on with the ON/OFF button. The version appears on the display in a couple of seconds if it is 1.02 or greater. If it does not appear, contact Vaisala or a Vaisala representative for further information.

8.1 Entering the setup mode

For entering the setup mode, first press the ON/OFF button and the following appears:

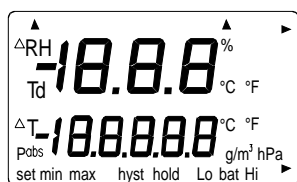

Then release the ON/OFF button and within 1 - 2 seconds press simultaneously both ENTER and MODE buttons until the following text appears on the display:



After a few seconds, the text changes automatically to show the following:

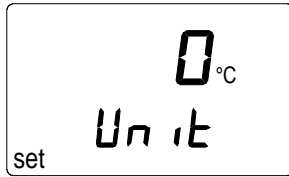

You can scroll the setup menu by pressing ENTER.

8.2 Selecting the display units

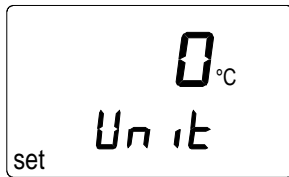

You can now select the display units with buttons ▲ (number up) or ▼ (number down). Choose 0 for metric units or 1 for non-metric units (see Table 8.2). The temperature unit on the display changes accordingly. If you do not wish to change any other settings, press the ON/OFF button. If you wish to change some other settings, press ENTER; the display changes to show the setting of the automatic power-off function.

Table 8.2 Metric and non-metric units

quantity	metric	non-metric
RH	%RH	%RH
T	°C	°F
Td	°C	°F
a	g/m ³	gr/ft ³
x	g/kg	gr/lb
Tw	°C	°F

8.3 Setting the automatic power-off function

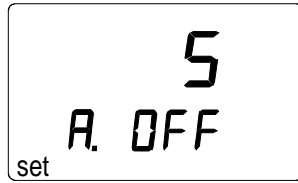

The number (or text NO) on the first line of the display indicates in minutes (1...60) the time that the HMI41 stays on before it automatically turns itself off if no buttons are pressed. The number is changed with buttons ▲ (number up) and ▼ (number down). If NO is chosen, the automatic power-off function is not activated. If you do not wish to change any other settings, press the ON/OFF button. If you wish to change some other settings, press ENTER; the display changes to show the selection of the display quantities.

8.4 Selecting the display quantities



The HMI41 displays relative humidity, temperature and dewpoint temperature readings. In addition to these, one of the following quantities can be chosen: absolute humidity, wet bulb temperature and mixing ratio. The number on the display indicates the following quantities:

- 0 = RH, T, Td
- 1 = RH, T, Td, abs
- 2 = RH, T, Td, Tw
- 3 = RH, T, Td, x

The number is changed with buttons ▲ (number up) and ▼ (number down). If you do not wish to change other settings, press the ON/OFF button. If you wish to change other settings, press ENTER; the display changes to show the setting of the pressure for mixing ratio and wet bulb temperature calculations.

8.5 Setting the pressure for mixing ratio and wet bulb temperature calculations

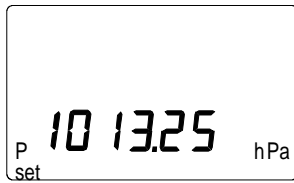

The pressure is changed (in steps of 0.25 hPa) with buttons ▲ (number up) and ▼ (number down). Acknowledge the pressure setting with ENTER and a text similar to the following appears:

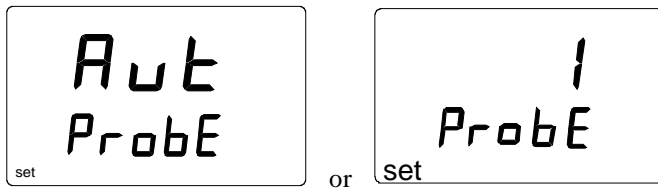

Indicators marked with letters ID have the automatic probe recognition as default (AUT PROBE) and previous versions the probe type 1. If the indicator does not recognize the probe type automatically, **set the type manually to 2** (see below) when using the HMP42.

8.6 Selecting the probe type

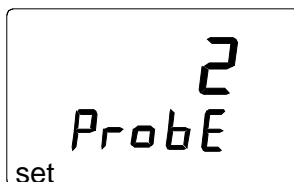

Change the setting with buttons ▲ (number up) and ▼ (number down). You have now completed the setup procedure; turn your indicator off.

NOTE

The HMI41 setup contains further settings (*start*, *baud*, *seri* and *calib*) that appear after probe type setting when pressing ENTER. *Start* setting is changed only when using the HMP44/44L probes (START 5, see the HM44 Operating Manual). For *calib*, see Chapter 5. Other settings are meant for the HMI41 used as a field calibrator for other Vaisala humidity transmitters. It is recommended that these settings are not changed.

9. MAINTENANCE

9.1 Changing the filter and the sensor head set

For changing the filter, unscrew the steel grid, remove the membrane filter (see Figure 9.1) and replace it with a new one. A set of membrane filters is delivered with the probe. Screw the steel grid back on.

NOTE

Do not use the probe without the membrane filter in order not to damage the sensors.

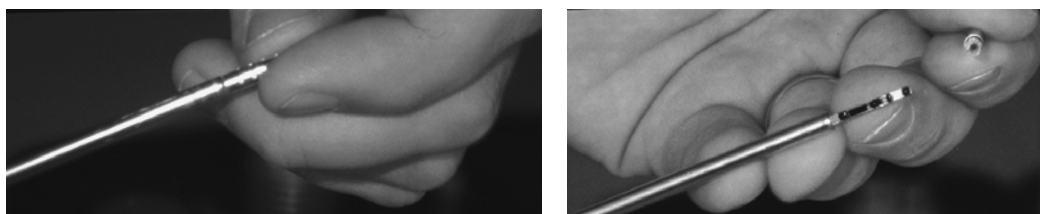

Figure 9.1 Changing the filter

If the steel grid looks dirty, remove it and clean the holes e.g. with a needle.

It is recommended that the sensor head set is changed by Vaisala authorized maintenance personnel only. However, if for some reason it is necessary to do this yourself, be careful not to break the sensor. Unscrew the sensor head set and mount a new set in its place. Handle the sensor head with care. Calibrate the probe using a two-point calibration procedure (see section 5.3.2).

9.2 Chemical tolerances of the HUMICAP®MINI sensor

Long-term exposure of the HUMICAP®MINI sensor to certain chemicals and gases may affect the characteristics of the sensor and shorten its life. The following table gives the recommended maximum ambient concentrations of some chemicals:

	ppm (typ.)
Organic solvents	1000...10 000
Aggressive chemicals (e.g. strong acids such as SO ₂ , H ₂ SO ₄ , H ₂ S, HCl, Cl ₂ , etc.)	1...10
Weak acids	100...1000
Bases	10 000...100 000

Detailed information on allowed concentrations can be requested from Vaisala representatives.

9.3 Spare parts and accessories

Order code	Description
19809HM	Rubber sleeve set (10 pcs)
HM37067	Calibration adapter
19858HM	Membrane filter set, 5 pcs (AISI 316/PTFE)
19867HM	Steel grid
HM27104	Carrying bag for HMI41 and HMP42
HM36959	Trimming screw wrench set 1.5 mm / 2.5 mm
HMP42P235SP	Sensor head set: RH and T sensors, filters and installation accessories
HMP41	RH & T probe; for fixed mounting
HMP42	RH & T probe; for tight places
HMP44/L	RH & T probe; for measurements in structures
HMP45	RH & T probe; cable model
HMP46	RH & T probe; cable model, for dirty or hot processes
19446ZZ	Serial interface cable for HMI41
19116ZZ	Calibration cable (for HMD/W60/70, HMP140 series)
19164ZZ	Calibration cable (for HMP230 series)
19165ZZ	Calibration cable (for HMD/W20/30, HMP130 series)
HMK15	Humidity Calibrator

10. IN CASE OF ERROR

The HMI41 goes through a continuous self-diagnostic procedure. If any problems occur, it displays the corresponding error message:

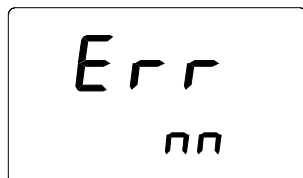

where nn = the number indicating the error

Whenever you come across an error message or your indicator does not function as it should, first check that the probe is correctly connected. Then check that the filter and the steel grid are clean.

10.1 Trouble shooting

In the following, a short list for trouble shooting:

PROBLEM:	WHAT TO DO:
the display is blank	<ul style="list-style-type: none"> - check the batteries (see Chapters 3.1 and 9.1) - if the batteries are ok, contact Vaisala or a Vaisala representative
the display is dim	<ul style="list-style-type: none"> - during automatic data collecting, the display is dim except when the readings are updated (once in a minute)
the readings seem to be wrong	<ul style="list-style-type: none"> - allow enough time for the probe to stabilize to the ambient temperature - check that the probe is correctly connected to the indicator - check that the steel grid and the membrane filter are clean - make sure that the measurement point is clean and that there is no condensated water - check that the settings are correct (see Chapter 10.2)
you have accidentally changed some settings	<ul style="list-style-type: none"> - enter the setup mode, select the setting with ENTER and change it with buttons ▲ or ▼ (see table on the next page). The pressure setting has to be acknowledged with ENTER.

10.2 Checking the settings

If these are in order, turn the HMI41 on and enter the setup mode (see Chapter 8). Make sure that the following settings are correct:

setting	correct value
<i>probe</i>	AUT or 2 (with HMP42)
<i>start</i> (*)	1
<i>baud</i>	4.8
<i>seri</i>	E.7.1
<i>calib</i>	def (**)

(*) values 2, 3 and 4 are for calibration cables

(**) when the *calib* setting is entered, the value is always “no”; factory settings for calibration correction data can be returned by selecting “def”

If the settings are not correct, change them: in the setup mode, select the setting with ENTER, change it with buttons ▲ or ▼ and acknowledge with ENTER. If the error message still appears, write it down and contact Vaisala or a Vaisala representative for further instructions.

11. TECHNICAL DATA

11.1 HMI41 indicator

Maximum measurement error
caused by the indicator at 20 °C
(for system accuracy, see probes' technical specifications)

humidity	± 0.1 %RH
temperature	± 0.1 °C
Calculated variables	dewpoint temperature, absolute humidity, wet bulb temperature, mixing ratio
Resolution	0.1 %RH; 0.1 °C
Power supply	4 batteries, type IEC LR6
Battery operation time	72 h continuous use
Operating humidity range	0...100 %RH non-condensing
Operating temperature	-20...+60 °C
Storage temperature	-40...+70 °C
Display	two line LCD
Housing material	ABS plastic
Housing classification	IP 53 (with connectors blocked)
Connector type	modular connector
Weight (incl. batteries)	300 g

11.2 HMP42 probe

11.2.1 Relative humidity

Measurement range 0...100 %RH non-condensing

Accuracy (at +20 °C)
when calibrated against
salt solutions (ASTM E104-85): ± 2 %RH (0...90 %RH)
 ± 3 %RH (90...100 %RH)

Temperature dependence
of electronics ± 0.05 %RH/ °C

Typical long-term stability better than 1 %RH per year

Response time (90%) at 20 °C
in still air with 30 s

Humidity sensor HUMICAP®MINI

11.2.2 Temperature

Measurement range
(sensor head) -40...+100 °C

Accuracy at +20 °C ± 0.2 °C

Accuracy:

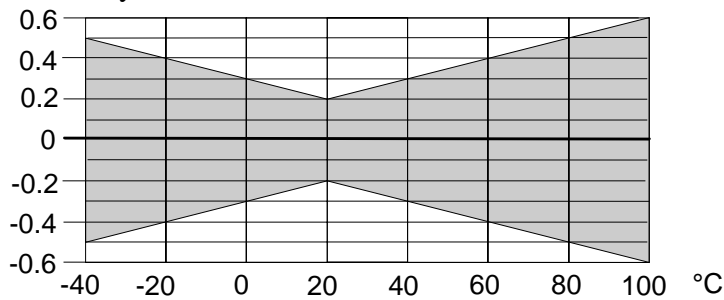

Temperature sensor Pt 100 (IEC 751 1/3 Class B)

11.2.3 General

Cable length	1500 mm; extended spiral cable
Connector type	modular connector
Operating temperature range for electronics	-20...+60 °C
Storage temperature range	-40...+100 °C
Housing material	ABS plastic
Housing classification (electronics)	IP65 (NEMA 4)
Sensor protection	steel grid with membrane filter
Weight	200 g

Dimensions (in mm):

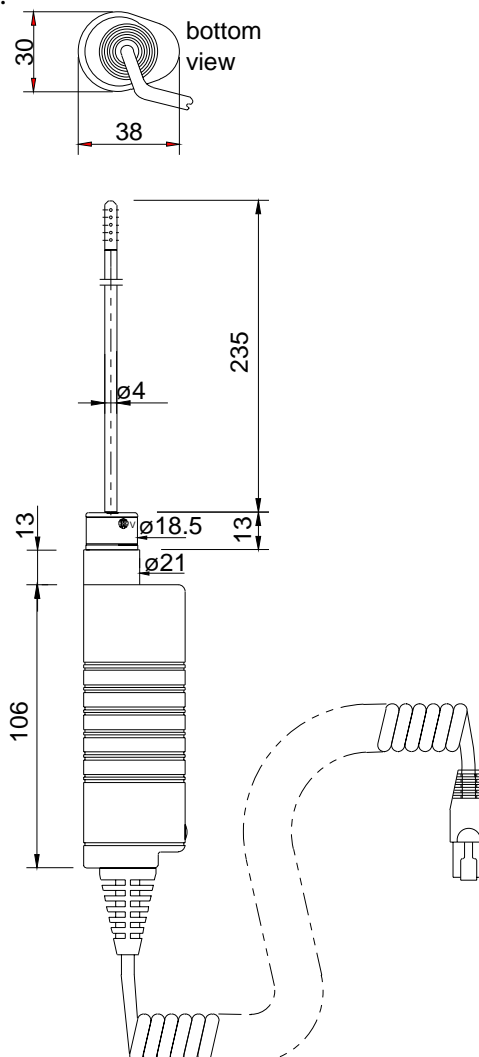

11.4 Accuracy of the calculated quantities

Dewpoint temperature, mixing ratio, absolute humidity and wet bulb temperature are calculated from the measured relative humidity and temperature values. The accuracy of the calculated quantities depends on the calibration of the probe and on performing the measurement correctly. In tables below the accuracies of the measured values are $\pm 2\%$ RH and $\pm 0.2^\circ\text{C}$.

11.4.1 Accuracies in metric units

		Accuracy of dewpoint temperature ($^\circ\text{C}$)									
		RH/%									
		10	20	30	40	50	60	70	80	90	100
T/ $^\circ\text{C}$	-40	1.82	1.00	0.74	0.61	0.53	0.48	0.44	0.42	-	-
	-20	2.09	1.14	0.83	0.68	0.59	0.53	0.49	0.45	-	-
	0	2.51	1.37	1.00	0.81	0.70	0.63	0.57	0.53	0.50	0.48
	20	2.87	1.56	1.13	0.92	0.79	0.70	0.64	0.59	0.55	0.53
	40	3.24	1.76	1.27	1.03	0.88	0.78	0.71	0.65	0.61	0.58
	60	3.60	1.96	1.42	1.14	0.97	0.86	0.78	0.72	0.67	0.64
	80	4.01	2.18	1.58	1.27	1.08	0.95	0.86	0.79	0.74	0.70
	100	4.42	2.41	1.74	1.40	1.19	1.05	0.95	0.87	0.81	0.76
	120	4.86	2.66	1.92	1.54	1.31	1.16	1.04	0.96	0.89	0.84
	140	5.31	2.91	2.10	1.69	1.44	1.27	1.14	1.05	0.97	0.91
	160	5.80	3.18	2.30	1.85	1.57	1.38	1.24	1.14	1.06	0.99

		Accuracy of mixing ratio (g/kg) with ambient pressure of 1013.25 mbar									
		RH/%									
		10	20	30	40	50	60	70	80	90	100
T/ $^\circ\text{C}$	-40	0.002	0.002	0.002	0.002	0.003	0.003	0.003	0.003	-	-
	-20	0.014	0.015	0.017	0.018	0.019	0.020	0.022	0.023	-	-
	0	0.08	0.09	0.09	0.10	0.10	0.11	0.12	0.12	0.13	0.13
	20	0.31	0.33	0.35	0.37	0.39	0.41	0.43	0.45	0.47	0.49
	40	0.97	1.03	1.10	1.17	1.24	1.31	1.38	1.46	1.54	1.62
	60	2.70	2.94	3.46	3.76	3.72	4.08	4.42	4.79	5.19	5.63
	80	6.78	7.80	9.00	10.4	12.2	14.3	16.9	20.2	24.4	29.7
	100	16.4	21.6	29.2	41.3	62.0	101	190	462	-	-
	120	41.2	75.7	176	-	-	-	-	-	-	-
	140	-	-	-	-	-	-	-	-	-	-
	160	-	-	-	-	-	-	-	-	-	-

		Accuracy of absolute humidity (g/m³)									
		RH/%									
		10	20	30	40	50	60	70	80	90	100
T/°C											
	-40	0.003	0.003	0.003	0.003	0.004	0.004	0.004	0.005	-	-
	-20	0.020	0.021	0.023	0.025	0.026	0.028	0.029	0.031	-	-
	0	0.10	0.11	0.12	0.13	0.13	0.14	0.15	0.15	0.16	0.17
	20	0.37	0.39	0.41	0.43	0.45	0.47	0.49	0.51	0.53	0.55
	40	1.08	1.13	1.18	1.24	1.29	1.34	1.39	1.44	1.49	1.54
	60	2.73	2.84	2.95	3.07	3.18	3.29	3.40	3.52	3.63	3.74
	80	6.08	6.30	6.51	6.73	6.95	7.17	7.39	7.61	7.83	8.05
	100	12.2	12.6	13.0	13.4	13.8	14.2	14.6	15.0	15.3	15.7
	120	22.6	23.3	23.9	24.6	25.2	25.8	26.5	27.1	27.8	28.4
	140	39.1	40.0	41.0	42.0	43.0	44.0	45.0	45.9	46.9	47.9
	160	63.5	64.9	66.4	67.8	69.2	70.7	72.1	73.5	75.0	76.4

		Accuracy of wet bulb temperature (°C)									
		RH/%									
		10	20	30	40	50	60	70	80	90	100
T/°C											
	-40	0.20	0.20	0.20	0.20	0.20	0.20	0.20	0.20	-	-
	-20	0.21	0.21	0.21	0.21	0.22	0.22	0.22	0.22	-	-
	0	0.27	0.28	0.28	0.29	0.29	0.29	0.30	0.30	0.31	0.31
	20	0.45	0.45	0.45	0.44	0.44	0.44	0.43	0.43	0.42	0.42
	40	0.84	0.77	0.72	0.67	0.64	0.61	0.58	0.56	0.54	0.52
	60	1.45	1.20	1.03	0.91	0.83	0.76	0.71	0.67	0.63	0.61
	80	2.24	1.64	1.32	1.13	0.99	0.90	0.82	0.76	0.72	0.68
	100	3.06	2.04	1.58	1.31	1.14	1.01	0.92	0.85	0.80	0.75
	120	3.86	2.41	1.81	1.48	1.28	1.13	1.03	0.95	0.88	0.83
	140	4.57	2.73	2.03	1.65	1.41	1.25	1.13	1.04	0.97	0.91
	160	5.23	3.04	2.24	1.81	1.55	1.36	1.23	1.13	1.05	0.98

11.4.2 Accuracies in non-metric units

		Accuracy of dewpoint temperature (°F)									
		RH/%									
		10	20	30	40	50	60	70	80	90	100
T/°F											
	-40	3.28	1.80	1.33	1.10	0.96	0.86	0.80	0.75	-	-
	-4	3.76	2.05	1.50	1.22	1.06	0.95	0.88	0.82	-	-
	32	4.52	2.47	1.80	1.46	1.26	1.13	1.03	0.96	0.90	0.86
	68	5.16	2.81	2.04	1.65	1.42	1.26	1.15	1.06	1.00	0.95
	104	5.83	3.16	2.29	1.85	1.58	1.40	1.27	1.18	1.10	1.04
	140	6.48	3.53	2.55	2.05	1.75	1.55	1.41	1.30	1.21	1.14
	176	7.22	3.93	2.84	2.28	1.95	1.72	1.55	1.43	1.33	1.26
	212	7.95	4.34	3.13	2.52	2.15	1.89	1.71	1.57	1.46	1.38
	248	8.75	4.78	3.45	2.77	2.36	2.08	1.88	1.72	1.60	1.50
	284	9.56	5.24	3.78	3.04	2.59	2.28	2.05	1.88	1.75	1.64
	320	10.4	5.73	4.14	3.33	2.83	2.49	2.24	2.05	1.90	1.79

Accuracy of mixing ratio (gr/lb) with ambient pressure of 1013.25 mbar											
		RH/%									
		10	20	30	40	50	60	70	80	90	100
T/°F	-40	0.013	0.014	0.015	0.016	0.018	0.019	0.020	0.021	-	-
	-4	0.099	0.108	0.116	0.125	0.134	0.142	0.151	0.159	-	-
	32	0.57	0.61	0.65	0.69	0.73	0.77	0.81	0.85	0.89	0.93
	68	2.17	2.31	2.44	2.58	2.72	2.87	3.01	3.15	3.30	3.44
	104	6.85	7.31	7.77	8.25	8.74	9.25	9.77	10.3	10.9	11.4
	140	18.9	20.6	22.3	24.2	26.3	28.5	30.9	33.5	36.4	39.4
	176	47.5	54.6	63.0	73.1	85.2	100	118	141	170	208
	212	115	151	205	289	434	709	1329	3237	-	-
	248	288	530	1235	-	-	-	-	-	-	-
	284	-	-	-	-	-	-	-	-	-	-
	320	-	-	-	-	-	-	-	-	-	-

Accuracy of absolute humidity (gr/ft³)											
		RH/%									
		10	20	30	40	50	60	70	80	90	100
T/°F	-40	0.001	0.001	0.001	0.002	0.002	0.002	0.002	0.002	-	-
	-4	0.009	0.009	0.010	0.011	0.011	0.012	0.013	0.014	-	-
	32	0.046	0.049	0.052	0.055	0.058	0.060	0.063	0.066	0.069	0.072
	68	0.16	0.17	0.18	0.19	0.20	0.21	0.21	0.22	0.23	0.24
	104	0.47	0.49	0.52	0.54	0.56	0.58	0.61	0.63	0.65	0.67
	140	1.19	1.24	1.29	1.34	1.39	1.43	1.48	1.53	1.58	1.63
	176	2.65	2.74	2.84	2.94	3.03	3.13	3.22	3.32	3.41	3.51
	212	5.33	5.50	5.67	5.84	6.01	6.18	6.35	6.52	6.69	6.86
	248	9.87	10.2	10.4	10.7	11.0	11.3	11.5	11.8	12.1	12.4
	284	17.0	17.5	17.9	18.3	18.7	19.2	19.6	20.0	20.5	20.9
	320	27.7	28.3	28.9	29.6	30.2	30.8	31.4	32.1	32.7	33.3

Accuracy of wet bulb temperature (°F)											
		RH/%									
		10	20	30	40	50	60	70	80	90	100
T/°F	-40	0.36	0.36	0.36	0.36	0.36	0.36	0.36	0.37	-	-
	-4	0.37	0.38	0.38	0.38	0.39	0.39	0.40	0.40	-	-
	32	0.49	0.50	0.51	0.51	0.52	0.53	0.54	0.55	0.55	0.56
	68	0.82	0.81	0.81	0.80	0.79	0.78	0.78	0.77	0.76	0.76
	104	1.51	1.39	1.29	1.21	1.15	1.09	1.05	1.00	0.97	0.94
	140	2.62	2.16	1.86	1.64	1.49	1.37	1.28	1.20	1.14	1.09
	176	4.03	2.96	2.38	2.03	1.79	1.61	1.48	1.38	1.29	1.22
	212	5.52	3.68	2.84	2.36	2.05	1.83	1.66	1.54	1.44	1.36
	248	6.94	4.33	3.26	2.67	2.30	2.04	1.85	1.70	1.59	1.49
	284	8.23	4.92	3.65	2.97	2.54	2.25	2.03	1.87	1.74	1.63
	320	9.41	5.48	4.03	3.26	2.78	2.45	2.21	2.03	1.89	1.77

11.5 Electromagnetic compatibility

Complies with the following standard:

EN 61326-1:1997 +Am 1:1998, Electrical equipment for measurement, control and laboratory use - EMC requirements: Light environment.



APPENDIX 1: QUICK REFERENCE TO COMMANDS

1. DISPLAY TEXTS AND OPERATING COMMANDS	53
2. CALIBRATION WITH THE HMI41 SOFTWARE	55
2.1 One-point humidity calibration.....	55
2.2 Two-point humidity calibration.....	56
2.3 One-point temperature calibration.....	57
2.4 Two-point temperature calibration.....	58
3. DATA COLLECTING MODE	59
3.1 Manual data collecting.....	59
3.2 Setting the measurement duration for automatic data collecting	60
3.3 Setting the measurement interval for automatic data collecting.....	60
3.4 Reading the measurement results	61
3.4.1 MIN and MAX in the data collecting mode.....	62
4. TRANSFERRING THE MEASURED DATA TO A PC.....	63
4.2 Using the serial commands	65
4.2.1 PLAY Transferring the data.....	65
4.2.2 CPLAY Setting characters between decimals and fields.....	65
4.2.3 HELP Outputting available commands and their contents	66
4.3.4 ? Outputting the HMI41 settings.....	66
5. SETUP	67



1. DISPLAY TEXTS AND OPERATING COMMANDS

The HMI41 is used by simply turning it on with the ON/OFF button. In the following, you will find a summary of the display texts with explanations and the operating commands.

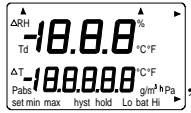
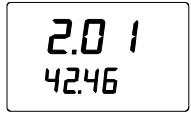
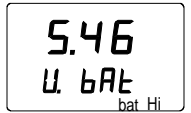
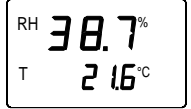
ON/OFF: the HMI41 is turned ON or OFF

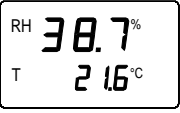
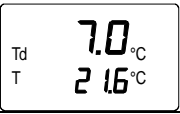

DISPLAY	DESCRIPTION
	The HMI41 has been turned on.
	The HMI41 software version and probe type indication. If the software version does not appear, it is less than 1.02 and the HMI41 cannot be used with the HMP46; contact Vaisala or a Vaisala representative. If the probe type indication (42.46) does not appear, the indicator does not recognize the probe type automatically; give the setting manually (see Chapter 4 of this appendix). If the probe type indication is replaced with text NO PRB , check that the probe is correctly connected.
	Indication of the battery voltage.
	Relative humidity and temperature readings are output.

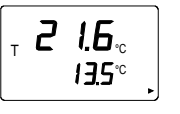
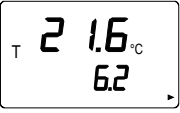
MODE: outputting of the selected quantities

	<p>Relative humidity and temperature readings are output (automatically after power-up). PRESS MODE (the following appears):</p>
	<p>Dewpoint temperature and temperature readings are output. PRESS MODE (return to the normal RH&T display or one of the following appears):</p>
	<p>Absolute humidity and temperature readings are output if absolute humidity has been selected during the setup procedure. PRESS MODE (return to the RH&T display)</p>
	<p>Wet bulb temperature and temperature readings are output if wet bulb temperature has been selected during the setup procedure. PRESS MODE (return to the RH&T display)</p>
	<p>Mixing ratio and temperature readings are output if mixing ratio has been selected during the setup procedure. PRESS MODE (return to the RH&T display)</p>

HOLD:

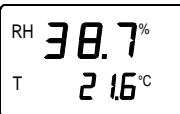

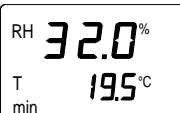
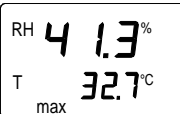
freezes the display to show the current readings or outputs the minimum or maximum values measured after power-up.

	<p>Relative humidity and temperature readings are output in the normal display mode. PRESS HOLD (the following appears):</p>
	<p>The display is frozen to show the current readings. This mode is available for all quantities. PRESS HOLD for the second time:</p>
	<p>The minimum readings after power-up are output. This mode is available for all quantities. PRESS HOLD for the third time:</p>
	<p>The maximum readings after power-up are output. This mode is available for all quantities. Return to the normal RH&T display mode with any button except ON/OFF.</p>



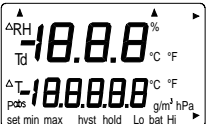

2. CALIBRATION WITH THE HMI41 SOFTWARE

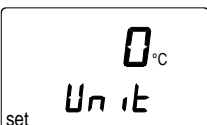
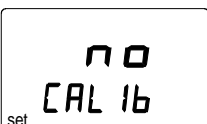
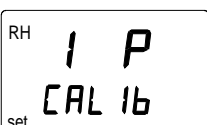
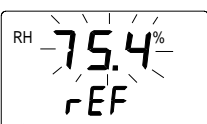
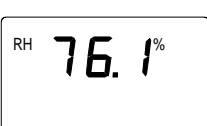
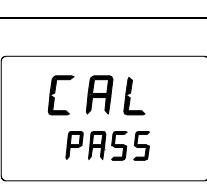
This quick reference is meant for those users who already know how to use the HMI41 indicator. The operating manual gives more detailed instructions. NOTE: it is recommended that the calibration is done with trimmer potentiometers of the probe. However, if only one probe is being used, the calibration can also be done according to the following instructions.



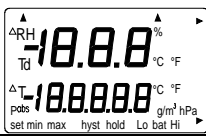

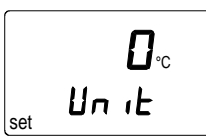
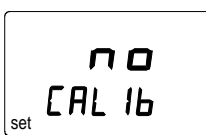
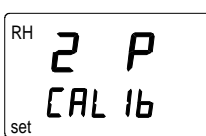
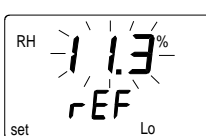
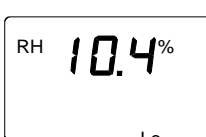
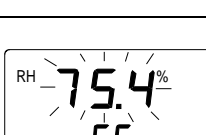
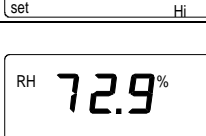
2.1 One-point humidity calibration

	<p>Turn the HMI41 indicator on. Within 1-2 seconds press simultaneously buttons MODE and HOLD until the text SETUP appears.</p>
	<p>Wait a few seconds.</p>
	<p>Press ENTER eight times.</p>
	<p>Press MODE twice.</p>
	<p>Press ENTER to activate one point humidity calibration.</p>
	<p>The reference humidity reading stored in the HMI41 memory is blinking. Change it to the correct value (see calibration table) with buttons ▲ or ▼. The reading changes in steps of 0,1 %. Press ENTER.</p>
	<p>The indicator shows the value that the probe is measuring. Wait at least 10 minutes for the reading to stabilize and acknowledge it by pressing ENTER. Press ENTER again to conclude the calibration.</p>
	<p>Calibration was successful. If it was not successful, some other text appears on the display (e.g. <i>too close, err offst or err gain</i>). Perform the calibration again.</p>



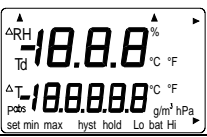

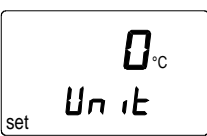
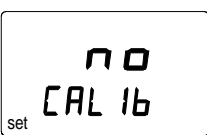
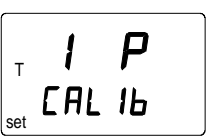

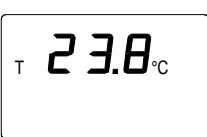
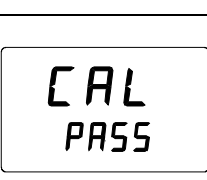

2.2 Two-point humidity calibration

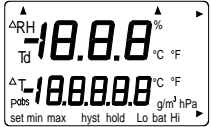
	<p>Turn the HMI41 indicator on. Within 1-2 seconds press simultaneously buttons MODE and HOLD until the text SETUP appears.</p>
	<p>Wait a few seconds.</p>
	<p>Press ENTER eight times.</p>
	<p>Press MODE three times.</p>
	<p>Press ENTER to activate two point humidity calibration.</p>
	<p>The lower reference reading stored in the HMI41 memory is blinking. Change it to the correct value (see calibration table) with buttons ▲ or ▼. Press ENTER.</p>
	<p>The indicator shows the value that the probe is currently measuring. Wait at least 10 minutes for the reading to stabilize and acknowledge it with ENTER. Press ENTER again to conclude the lower point calibration.</p>
	<p>The higher reference reading stored in the HMI41 memory is blinking. Change it to the correct value (see calibration table) with buttons ▲ or ▼. Press ENTER.</p>
	<p>The indicator shows the value that the probe is currently measuring. Wait at least 10 minutes for the reading to stabilize and acknowledge it with ENTER. Press ENTER again to conclude the calibration.</p>
	<p>Calibration was successful. If it was not successful, some other text appears on the display (e.g. <i>too close</i>, <i>err offst</i> or <i>err gain</i>). Perform the calibration again.</p>

2.3 One-point temperature calibration

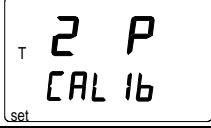
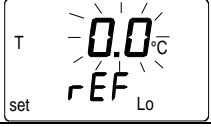
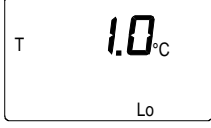

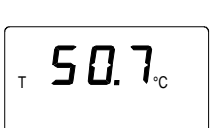

	<p>Turn the HMI41 indicator on. Within 1-2 seconds press simultaneously buttons MODE and HOLD until the text SETUP appears.</p>
	<p>Wait a few seconds.</p>
	<p>Press ENTER eight times.</p>
	<p>Press MODE four times.</p>
	<p>Press ENTER to activate one point temperature calibration.</p>
	<p>The reference reading stored in the HMI41 memory is blinking. Change it to the correct value with buttons ▲ or ▼. Press ENTER.</p>
	<p>The indicator shows the value that the probe is currently measuring. Wait at least 10 minutes for the reading to stabilize and acknowledge it with ENTER. Press ENTER again to conclude the calibration.</p>
	<p>Calibration was successful. If it was not successful, some other text appears on the display (e.g. <i>too close, err offst</i> or <i>err gain</i>). Perform the calibration again.</p>

2.4 Two-point temperature calibration



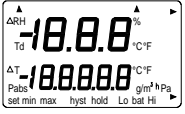

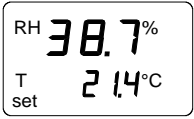
	<p>Turn the HMI41 indicator on. Within 1-2 seconds press simultaneously buttons MODE and HOLD until the text SETUP appears.</p>
	<p>Wait a few seconds.</p>
	<p>Press ENTER eight times.</p>
	<p>Press MODE five times.</p>
	<p>Press ENTER to activate two-point temperature calibration.</p>
	<p>The lower reference reading stored in the HMI41 memory is blinking. Change it to the correct value with buttons ▲ or ▼. Press ENTER.</p>
	<p>The indicator shows the value that the probe is currently measuring. Wait at least 10 minutes for the reading to stabilize and acknowledge it with ENTER. Press ENTER again to conclude the lower point calibration.</p>
	<p>The higher reference reading stored in the HMI41 memory is blinking. Change it to the correct value with buttons ▲ or ▼. Press ENTER.</p>
	<p>The indicator shows the value that the probe is currently measuring. Wait at least 10 minutes for the reading to stabilize and acknowledge it with ENTER. Press ENTER again to conclude the calibration.</p>
	<p>Calibration was successful. If it was not successful, some other text appears on the display (e.g. <i>too close</i>, <i>err offst</i> or <i>err gain</i>). Perform the calibration again.</p>

3. DATA COLLECTING MODE

3.1 Manual data collecting

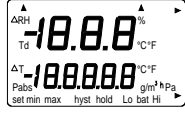
	<p>Turn the indicator on. Within 1 - 2 seconds press the button HOLD until the text REC AUTO appears, then release the button.</p>
	<p>Press the button MODE to enter the manual data collecting.</p>
	<p>Press ENTER to start the measurements.</p>
	<p>The probe is now taking measurements. You can store the readings at appropriate intervals by pressing the button HOLD. This brings the sequence number of the reading in the indicator's memory on the display for a couple of seconds:</p>
	<p>The indicator returns automatically to the previous display. The readings can be read in the REC READ mode (see chapter 3.4 of this appendix). You can store max. 199 readings in the indicator memory. Stop the data collecting by turning the indicator off.</p>



3.2 Setting the measurement duration for automatic data collecting

	<p>Turn the indicator on. Within 1 - 2 seconds press the button HOLD until the text REC AUTO appears, then release the button.</p>
	<p>Press ENTER when the text REC AUTO is displayed.</p>
	<p>Previously set duration time appears. If the previously set duration is too long for the current battery charge, the calculated longest duration time possible for the current battery charge appears instead; this is also indicated with the text MAX.</p>
	<p>Set the duration time with buttons ▲ or ▼. The duration time can be set from 15 minutes to 7 days. Text BAT on the display indicates that the battery charge is not sufficient for the duration time selected; select a shorter duration time. Turn the indicator off or press ENTER for setting the measurement interval.</p>

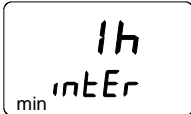
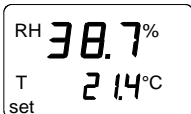
3.3 Setting the measurement interval for automatic data collecting

	<p>Previously set measurement interval appears. If the previously set interval is too long for the indicator's current memory capacity, the calculated shortest possible interval appears instead; this is also indicated with the text MIN. Select the interval with buttons ▲ or ▼. Text LO on the display indicates that there is not enough memory left for the chosen interval; select a longer interval. Press ENTER to activate the measurements in the automatic data collecting mode.</p>
	<p>Press ON/OFF if you wish to stop the automatic data collecting.</p>

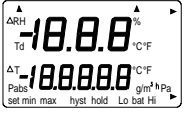
3.4 Reading the measurement results

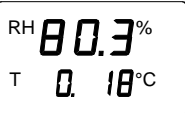
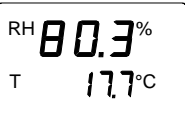
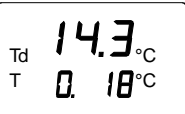
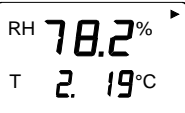
	<p>Turn the indicator on. Within 1 - 2 seconds press the button HOLD until the text REC AUTO appears, then release the button.</p>
	<p>Press twice the button MODE.</p>
	<p>Press ENTER.</p>
	<p>Numbers on the first line indicate the stored reading of the quantity shown; numbers on the left of the second line indicate the sequence number of the stored reading in the indicator memory. Numbers on the right of the second line indicate the temperature measured simultaneously with the first line reading. Press ENTER to see the decimals of the T reading:</p>
	<p>The display returns to the previous display after a couple of seconds.</p>
	<p>You can change the quantity on the first line by pressing MODE.</p>
	<p>To scroll all measurement results, press ENTER. An arrow is displayed on the higher righthand corner. Press HOLD while the arrow is displayed. Note that the sequence number changes.</p>

3.4.1 MIN and MAX in the data collecting mode

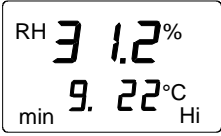
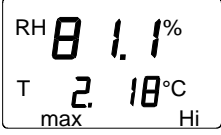
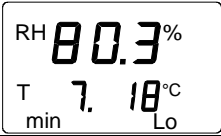
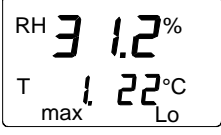
 <p>RH 3 1.2% min 9.22°C Hi</p>	<p>In this example, the minimum value of the first line reading is being observed (MIN = minimum, HI = the first line reading); press ENTER to see the T reading with decimals.</p>
 <p>RH 8 1.1% T 2.18°C max Hi</p>	<p>In this example, the maximum value of the first line reading is being observed (MAX = maximum, HI = the first line reading); press ENTER to see the T reading with decimals.</p>
 <p>RH 80.3% T 7.18°C min Lo</p>	<p>In this example, the minimum value of the second line reading is being observed (MIN = minimum, LO = the 2nd line reading); press ENTER to see the T reading with decimals.</p>
 <p>RH 3 1.2% T 1.22°C max Lo</p>	<p>In this example, the maximum value of the second line reading is being observed (MAX = maximum, LO = the 2nd line reading); press ENTER to see the T reading with decimals.</p>

4. TRANSFERRING THE MEASURED DATA TO A PC

Give the communication parameters when using this terminal session for the first time; save them for future use. See instructions in the following tables.

Table 4.1 Giving parameters in Windows 3.1

MENU	DESCRIPTION
PROGRAM MANAGER	
↓	
ACCESSORIES	double click
↓	
TERMINAL	double click
↓	
Settings	click
↓	
Communications	click and select parameters (see list below); click OK
↓	move the cursor to:
File	click
↓	
Save as	click and save settings: type the name of the file (e.g. HMI41) and click OK
Turn the HMI41 on and follow the instructions in Ch. 4.2	

The communication parameters are:

- connector according to your computer
- baud rate 4800
- data bits 7
- stop bits 1
- parity even
- flow control none

Table 4.2 Giving parameters in Windows 95 and Windows NT

WINDOWS 95		WINDOWS NT	
MENU	WHAT TO DO	MENU	WHAT TO DO
Start		Start	
↓	move the cursor to:	↓	move the cursor to:
Programs		Programs	
↓	move the cursor to:	↓	move the cursor to:
Accessories		Accessories	
↓	move the cursor to:	↓	move the cursor to:
HyperTerminal	click	HyperTerminal	
↓	move the cursor to:	↓	move the cursor to:
Hypertrm	double click	Hyperterminal	click
↓		↓	
Connection Description	type the name of the connection (e.g. HMI41) in the appropriate field and select an icon if available; click OK.	Connection Description	type the name of the connection (e.g. HMI41) in the appropriate field and select an icon if available; click OK.
↓			
Phone Number	move the cursor to the field CONNECT USING and select ' direct to COM x ' (x = serial port available); click OK	Connect to	move the cursor to the field CONNECT USING and select ' COM x ' (x = serial port available); click OK
↓		↓	
COM x properties	select parameters according to the list on previous page; click OK	COM x properties	select parameters according to the list on previous page; click OK
Turn the HMI41 on and follow the instructions in Chapter 4.2			

4.2 Using the serial commands

4.2.1 PLAY Transferring the data

To output the stored readings on your computer, turn the HMI41 on, type `PLAY` and press `ENTER`. An example of outputting automatically stored readings:

```
>play
Reading Log... OK

data    hh:mm:ss          RH      T      Td
  0     00:00:00      12.54  21.53  -8.48
  1     00:01:00      12.10  21.23  -9.16
  2     00:02:00      12.18  21.18  -9.12
  3     00:03:00      12.12  21.15  -9.21
  4     00:04:00      12.16  21.14  -9.18
  5     00:05:00      12.09  21.12  -9.27
  6     00:06:00      12.09  21.09  -9.28
>
```

An example of outputting manually stored readings:

```
>play
Reading Log... OK

data    RH      T      Td
  1     12.10  21.23  -9.16
  2     12.18  21.18  -9.12
  3     12.12  21.15  -9.21
  4     12.16  21.14  -9.18
  5     12.09  21.12  -9.27
  6     12.09  21.09  -9.28
>
```

If you know the starting time of the automatic data collecting, type it with the command; for example:

```
>play 15:05
Reading Log... OK

data    hh:mm:ss          RH      T      Td
  0     15:05:00      8.52   23.69  -11.70
  1     15:06:00      9.58   23.66  -10.26
  2     15:07:00      9.60   23.50  -10.35
  3     15:08:00      9.61   23.30  -10.48
  4     15:09:00      9.65   23.25  -10.47
  5     15:10:00     11.22  23.41   -8.44
  6     15:11:00      9.93   23.30  -10.08
  7     15:12:00      9.92   23.22  -10.15
>
```

4.2.2 CPLAY Setting characters between decimals and fields

Type `CPLAY` and press `ENTER` to see the characters between decimals and fields. An example:

```
>cplay
Desimal separator : .
Field separator   : TAB
example:
  1     01:00:00      38.72  21.61   7.01
>
```

To change the output, type CPLAY, the character you wish to appear between decimals, the character you wish to use between fields and then <cr>. An example:

```
>cplay ,      <cr>
Decimal separator : ,
Field separator   : TAB

example:
  1      01:00:00      38,72  21,61  7,01
>
```

4.2.3 HELP Outputting available commands and their contents

Type HELP and press ENTER:

```
>help
Available commands :
HELP      ?      PLAY      CPLAY
Type HELP <command_name> for more help
>
```

To see the contents of each command, type HELP, command name (e.g. PLAY) and press ENTER:

```
>help play

Command : PLAY
Purpose : Send recordings from memory to serial port
Usage   : PLAY hh:mm <cr>, hh:mm = rec starting time (optional)

if command is used without parameters it uses default setting
>
```

4.3.4 ? Outputting the HMI41 settings

Type ? and press ENTER:

```
>?

HMI41 / 2.01
Serial number : A0000000
Output units  : metric
Baud P D S   : 4800 E 7 1 FDX
Pressure     : 1013.25
Auto Off     : 5
Probe       : 2
Start-up mode : 1
4.th variable : none
>
```







To exit the terminal session, go to FILE menu and select EXIT. Confirm that you wish to quit and then select whether you wish to store the parameters of this session for future use or not (SAVE - YES/NO).

5. SETUP

The HMI41 factory settings are the following:

- display units: **0** (metric)
- automatic power-off: **5** (minutes)
- display quantities: **0** (RH, T and Td)
- pressure: **1013.25 hPa** (1 hPa = 1 mbar)
- probe type: **AUT** (or **1**, see below)
- start: **1**

Indicators marked with letters ID have the automatic probe recognition (AUT PROBE) as default, previous versions the probe type 1. With previous versions, set the probe type setting manually to PROBE TYPE **2** when using the HMP42. To change the setting, press ON/OFF until you can see some text on the display. Release the ON/OFF button and press within 1-2 seconds simultaneously both ENTER and MODE buttons until the text "**SEtUP**" appears on the display:

DISPLAY	WHAT TO DO	PRESS:
	Wait for a few seconds.	
	Select the display units: 0 = metric units 1 = non-metric units	▲ (number up) or ▼ (number down) ENTER(to scroll the menu) or ON/OFF (to exit the setup mode)
	Set the time for the automatic power-off in minutes (NO,1...60); if NO is chosen, the power-off function is not activated	▲ (up) or ▼ (down) ENTER (to scroll the menu) or ON/OFF (to exit the setup mode)
	Select the display quantities: 0 = RH, T, Td 1 = RH, T, Td, abs 2 = RH, T, Td, Tw 3 = RH, T, Td, x	▲ (up) or ▼ (down) ENTER(to scroll the menu) or ON/OFF (to exit the setup mode)
	Set the pressure for mixing ratio and wet bulb temperature calculations.	▲ (0.25 hPas up) or ▼ (0.25 hPas down) ENTER (to acknowledge the setting) ON/OFF (to exit the setup mode)
	Select the correct probe type: 1 = HMP41,HMP45 (HMP44/44L) 2 = HMP42 , HMP46	▲ (up) or ▼ (down) ON/OFF (to exit the setup mode)

NOTE

The HMI41 setup contains further settings (*start*, *baud*, *seri* and *calib*) that appear after probe type setting when pressing ENTER. *Start* setting is changed only when using the HMP44/L probes (START 5, see the HM44 Operating Manual). For *calib*, see the operating manual. Other settings are meant for the HMI41 used as a field calibrator for Vaisala humidity transmitters. Do not change them. Press ON/OFF after probe type setting.

Warranty

Vaisala hereby represents and warrants all Products manufactured by Vaisala and sold hereunder to be free from defects in workmanship or material during a period of twelve (12) months from the date of delivery save for products for which a special warranty is given. If any Product proves however to be defective in workmanship or material within the period herein provided Vaisala undertakes to the exclusion of any other remedy to repair or at its own option replace the defective Product or part thereof free of charge and otherwise on the same conditions as for the original Product or part without extension to original warranty time. Defective parts replaced in accordance with this clause shall be placed at the disposal of Vaisala.

Vaisala also warrants the quality of all repair and service works performed by its employees to products sold by it. In case the repair or service works should appear inadequate or faulty and should this cause malfunction or nonfunction of the product to which the service was performed Vaisala shall at its free option either repair or have repaired or replace the product in question. The working hours used by employees of Vaisala for such repair or replacement shall be free of charge to the client. This service warranty shall be valid for a period of six (6) months from the date the service measures were completed.

This warranty is however subject to following conditions:

- a) A substantiated written claim as to any alleged defects shall have been received by Vaisala within thirty (30) days after the defect or fault became known or occurred, and
- b) The allegedly defective Product or part shall, should Vaisala so require, be sent to the works of Vaisala or to such other place as Vaisala may indicate in writing, freight and insurance prepaid and properly packed and labelled, unless Vaisala agrees to inspect and repair the Product or replace it on site.

This warranty does not however apply when the defect has been caused through

- a) normal wear and tear or accident;
- b) misuse or other unsuitable or unauthorized use of the Product or negligence or error in storing, maintaining or in handling the Product or any equipment thereof;
- c) wrong installation or assembly or failure to service the Product or otherwise follow Vaisala's service instructions including any repairs or installation or assembly or service made by unauthorized personnel not approved by Vaisala or replacements with parts not manufactured or supplied by Vaisala;
- d) modifications or changes of the Product as well as any adding to it without Vaisala's prior authorization;
- e) other factors depending on the Customer or a third party.

Notwithstanding the aforesaid Vaisala's liability under this clause shall not apply to any defects arising out of materials, designs or instructions provided by the Customer.

This warranty is expressly in lieu of and excludes all other conditions, warranties and liabilities, express or implied, whether under law, statute or otherwise, including without limitation any implied warranties of merchantability or fitness for a particular purpose and all other obligations and liabilities of Vaisala or its representatives with respect to any defect or deficiency applicable to or resulting directly or indirectly from the Products supplied hereunder, which obligations and liabilities are hereby expressly cancelled and waived. Vaisala's liability shall under no circumstances exceed the invoice price of any Product for which a warranty claim is made, nor shall Vaisala in any circumstances be liable for lost profits or other consequential loss whether direct or indirect or for special damages.



www.vaisala.com

