

VAISALA

USER'S GUIDE

Vaisala HUMICAP® Set for Measuring Humidity in Concrete HM44



PUBLISHED BY

Vaisala Oyj
P.O. Box 26
FIN-00421 Helsinki
Finland

Phone (int.): +358 9 8949 1
Fax: +358 9 8949 2227

Visit our Internet pages at <http://www.vaisala.com/>

© Vaisala 2006

No part of this manual may be reproduced in any form or by any means, electronic or mechanical (including photocopying), nor may its contents be communicated to a third party without prior written permission of the copyright holder.

The contents are subject to change without prior notice.

Please observe that this manual does not create any legally binding obligations for Vaisala towards the customer or end user. All legally binding commitments and agreements are included exclusively in the applicable supply contract or Conditions of Sale.

Table of Contents

CHAPTER 1	
GENERAL INFORMATION	3
Safety	3
Version Information	3
Warranty	4
CHAPTER 2	
PRODUCT DESCRIPTION	5
CHAPTER 3	
TO BE NOTED WHEN MEASURING HUMIDITY	6
CHAPTER 4	
TAKEN INTO USE	7
Feeding the individual adjustment coefficients	7
Numbering the probes	8
Feeding the offset correction	8
Feeding the gain correction	8
Changing the settings	9
Enter the setup menu	9
Display units	10
Setting the automatic power-off function	10
Selecting the display quantities	11
Setting the pressure for mixing ratio and wet bulb temperature calculations	11
Setting the probe type	12
Select the function	12
CHAPTER 5	
HUMIDITY MEASUREMENTS IN CONCRETE	13
General about humidity measurements in a drilled hole ...	13
Measurement depth	13
Maximum humidity levels for coating	15
Preparations for the measurements	16
Starting the measurements	18
Measurement readings on display	19
HOLD-mode	19
MIN and MAX modes	19

CHAPTER 6

COLLECTING DATA 21

Data collecting modes..... 21

 Entering the data collecting modes..... 21

Automatic data collecting mode REC AUTO 22

 Setting the measurement duration..... 22

 Setting the measurement interval 23

Manual data collecting REC CATCH 24

Reading the measurement results REC READ 25

 MIN and MAX in data collecting REC READ mode 26

CHAPTER 7

TRANSFERRING DATA TO A PC 28

Giving the communication parameters 29

Transferring the data 31

 Commands..... 32

 PLAY Transferring the data 32

 CPLAY Setting characters between decimals and fields... 33

 HELP Outputting available commands and their contents 33

 ? Outputting the HMI41 settings 34

CHAPTER 8

CALIBRATION..... 35

Two-point humidity calibration..... 37

CHAPTER 9

MAINTENANCE 39

Replacing the HUMICAP[®] 180 sensor 39

Replacing the filter..... 39

CHAPTER 10

TROUBLESHOOTING 40

 Erroneous readings..... 40

 Trouble shooting 40

CHAPTER 11

SPARE PARTS AND ACCESSORIES..... 42

Optional probes..... 43

CHAPTER 12

TECHNICAL DATA..... 44

HMP44 probe 44

HMI41 indicator 45

CHAPTER 1

GENERAL INFORMATION

Safety

Throughout the manual, important safety considerations are highlighted as follows:

WARNING

Warning alerts you to a serious hazard. If you do not read and follow instructions very carefully at this point, there is a risk of injury or even death.

CAUTION

Caution warns you of a potential hazard. If you do not read and follow instructions carefully at this point, the product could be damaged or important data could be lost.

NOTE

Note highlights important information on using the product.

Version Information

Table 1 Manual Revisions

Manual Code	Description
U254en-1.3	March 1998
M010068en-A	

Warranty

Vaisala hereby represents and warrants all Products manufactured by Vaisala and sold hereunder to be free from defects in workmanship or material during a period of twelve (12) months from the date of delivery save for products for which a special warranty is given. If any Product proves however to be defective in workmanship or material within the period herein provided Vaisala undertakes to the exclusion of any other remedy to repair or at its own option replace the defective Product or part thereof free of charge and otherwise on the same conditions as for the original Product or part without extension to original warranty time. Defective parts replaced in accordance with this clause shall be placed at the disposal of Vaisala.

Vaisala also warrants the quality of all repair and service works performed by its employees to products sold by it. In case the repair or service works should appear inadequate or faulty and should this cause malfunction or nonfunction of the product to which the service was performed Vaisala shall at its free option either repair or have repaired or replace the product in question. The working hours used by employees of Vaisala for such repair or replacement shall be free of charge to the client. This service warranty shall be valid for a period of six (6) months from the date the service measures were completed.

This warranty is however subject to following conditions:

- a) A substantiated written claim as to any alleged defects shall have been received by Vaisala within thirty (30) days after the defect or fault became known or occurred, and
- b) The allegedly defective Product or part shall, should Vaisala so require, be sent to the works of Vaisala or to such other place as Vaisala may indicate in writing, freight and insurance prepaid and properly packed and labelled, unless Vaisala agrees to inspect and repair the Product or replace it on site.

This warranty does not however apply when the defect has been caused through

- a) normal wear and tear or accident;
- b) misuse or other unsuitable or unauthorized use of the Product or negligence or error in storing, maintaining or in handling the Product or any equipment thereof;
- c) wrong installation or assembly or failure to service the Product or otherwise follow Vaisala service instructions including any repairs or installation or assembly or service made by unauthorized personnel not approved by Vaisala or replacements with parts not manufactured or supplied by Vaisala;
- d) modifications or changes of the Product as well as any adding to it without Vaisala's prior authorization;
- e) other factors depending on the Customer or a third party.

Notwithstanding the aforesaid Vaisala's liability under this clause shall not apply to any defects arising out of materials, designs or instructions provided by the Customer.

This warranty is expressly in lieu of and excludes all other conditions, warranties and liabilities, express or implied, whether under law, statute or otherwise, including without limitation ANY IMPLIED WARRANTIES OF MERCHANTABILITY OR OF FITNESS FOR A PARTICULAR PURPOSE and all other obligations and liabilities of Vaisala or its representatives with respect to any defect or deficiency applicable to or resulting directly or indirectly from the Products supplied hereunder, which obligations and liabilities are hereby expressly cancelled and waived. Vaisala's liability shall under no circumstances exceed the invoice price of any Product for which a warranty claim is made, nor shall Vaisala in any circumstances be liable for lost profits or other consequential loss whether direct or indirect or for special damages.

CHAPTER 2

PRODUCT DESCRIPTION

The HM44 set is a practical tool for humidity measurements of concrete or other structures. The accuracy and reliability performance of the HMP44 probe comes from advanced Vaisala HUMICAP® 180 sensor.

The HM44 package includes:

- HMP44 humidity and temperature probe
- HMI41 indicator with batteries
- installation cover and lid, 3 pcs
- rubber plugs, 12 pcs
- plastic sleeves, 12 pcs
- carrying case
- user's guide

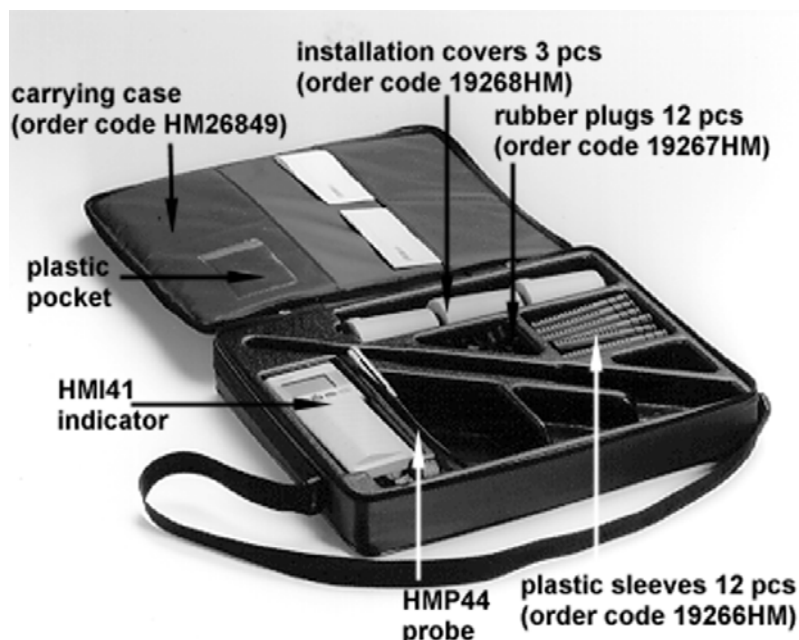

Figure 2.1 HM44 set for measuring humidity in concrete.

CHAPTER 3

TO BE NOTED WHEN MEASURING HUMIDITY**Temperature of the probe and the concrete shall be the same!**

In humidity measurement and especially in calibration it is essential that temperature of the probe and measured object is the same. Even a small difference in temperature between the measured object and the probe causes an error. As the curve below shows, if the temperature is +20 °C and the relative humidity 100 %RH, a difference of ± 1 °C between the measured object and the probe causes an error of ± 6 %RH. When the humidity is 90 %RH, the corresponding error is ± 5.4 %RH.

A temperature difference of a few degrees can also cause water to condense on the sensor surface. HUMICAP[®] sensor starts to function normally as soon as the water has evaporated. If the condensed water is contaminated, the life span of the probe may shorten and calibration may change.

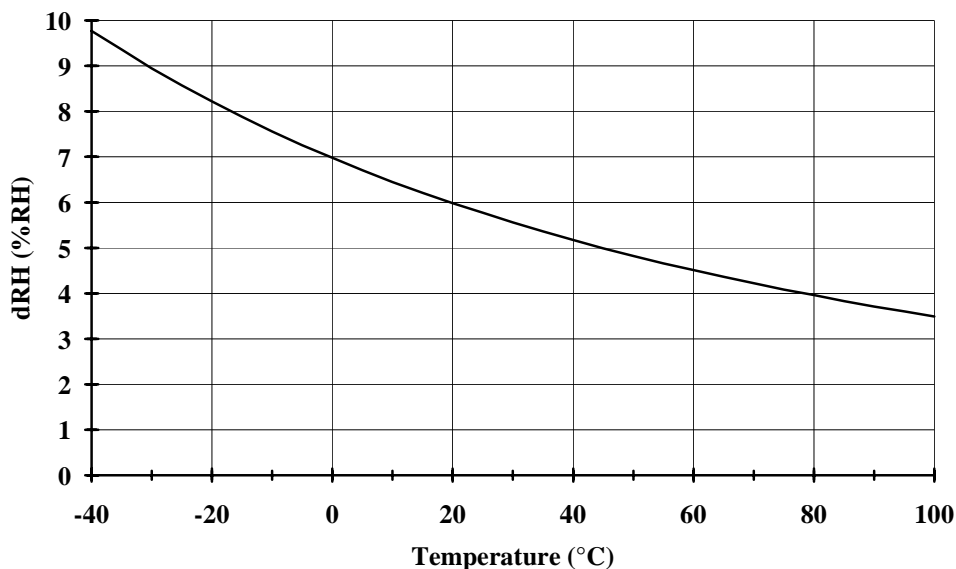

Figure 3.1 Measurement error at 100 %RH when the difference between the ambient and sensor temperature is 1 °C

CHAPTER 4

TAKEN INTO USE

Before taking into use the HM44 do the following:

- place the batteries into HMI indicator
- connect the probe
- feed the individual probe adjustment coefficients
- if needed, check and change the settings

The basic display appears when turning the device on:

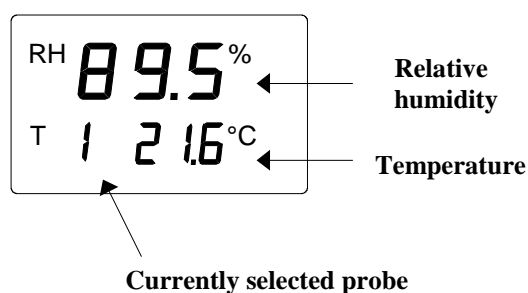

Feeding the individual adjustment coefficients

Each probe has an individual adjustment coefficients which are written in the calibration certificate (see Appendix 1). These coefficients should be fed to the HMI41 memory to reach the measurement accuracy of ± 2 %RH.

- When using one probe, numbering of the probe is not needed.
- When using more than one probe, firstly select a number for the probe and then feed the probe individual coefficients to the HMI41 memory. Remember to write the probe number (1-10) in the product label to be able to identify the probes afterwards.

Numbering the probes

The first number of the second line of display indicates the currently selected probe (1-10). Connect a probe and change the number on the display by pressing ENTER and simultaneously buttons ▲ or ▼. Remember to write the probe number (1-10) in the product label to be able to identify the probes.

Feeding the offset correction

1. Press the button ENTER continuously for about 5 seconds until a text similar to the following appears on the display (numbers on the second line are blinking):

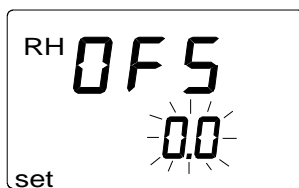

2. Feed the individual offset correction (see the calibration certificate) in the HMI41 memory with buttons ▲ and ▼. Each time the button is pressed, the numbers change 0.1 %RH. If the button is pressed continuously, the numbers change in a faster rate.
3. When the reading is correct, press ENTER and the display changes to show the gain correction.

Feeding the gain correction



4. Numbers on the second line are blinking; you can now enter the individual gain correction in the HMI41 memory. The numbers are changed with buttons ▲ and ▼. Each time the button is pressed, numbers change 0.001. If the button is pressed continuously, the numbers change in a faster rate.

NOTE

If the correction given in the calibration certificate has only two decimals (e.g. 1.03), enter a zero in place of the third decimal (e.g. 1.030).

5. When the reading is correct, press ENTER and the display changes to show the humidity and temperature readings. However, an arrow is now displayed as an indication of the individual corrections in the HMI41 memory:

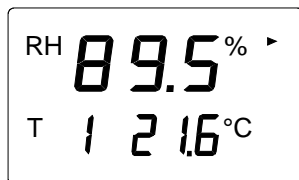

Changing the settings

Change the settings **ONLY** if there is a need to change the following factory settings:

Factory settings

- display units: **0** (metric)
- automatic power-off: **5** (minutes)
- display quantities: **0** (RH, T and Td)
- pressure: **1013.25 hPa** (1 hPa = 1 mbar)
- probe type: **AUT**
- start: **5**

To change the settings, enter the setup menu.

Enter the setup menu

Turn the device ON (by using ON/OFF button) and **immediately (within 1..2 seconds)** after turning on, press together both the buttons ENTER and MODE for about 3 seconds, until the following appears:



In a few seconds, the text changes automatically to the following:

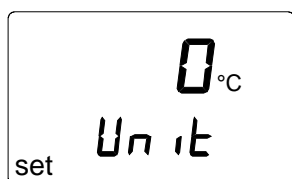

Display units

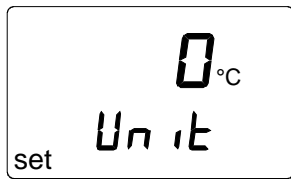

- Select the display units with buttons ▲ or ▼. Choose 0 for metric units or 1 for non-metric units (see Table 1).
- Press ENTER and the display changes to show the setting of the automatic power-off function.

Table 1. Metric and non-metric units

quantity	metric	non-metric
relative humidity (RH)	%RH	%RH
temperature (T)	°C	°F
dewpoint temperature (Td)	°C	°F
absolute humidity (a)	g/m ³	gr/ft ³
mixing ratio (x)	g/kg	gr/lb
wet bulb temperature (Tw)	°C	°F

Setting the automatic power-off function

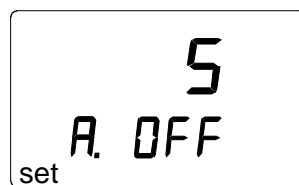

The number (or text NO) on the first line of the display indicates in minutes (1...60) the time that the HMI41 stays on before an automatic power-off if no buttons are pressed.

- changed with buttons ▲ and ▼. If NO is chosen, the automatic power-off function is not activated.
- Press ENTER and the display changes to show the selection of the display quantities. NOTE: during data collecting this setting is not valid.

Selecting the display quantities



The HMI41 displays relative humidity (RH), temperature (T) and dewpoint temperature (Td) readings. Additionally, one of the following quantities can be chosen: absolute humidity (a), wet bulb temperature (Tw) and mixing ratio (x). The number on the display indicates the following quantities:

- 0 = RH, T, Td
- 1 = RH, T, Td, abs
- 2 = RH, T, Td, Tw
- 3 = RH, T, Td, x

- select the number with buttons ▲ and ▼
- press ENTER and the display changes to show the setting of the pressure for mixing ratio and wet bulb temperature calculations.

Setting the pressure for mixing ratio and wet bulb temperature calculations

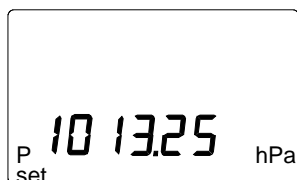

- change the pressure (in steps of 0.25 hPa) with buttons ▲ and ▼
- press ENTER; the display now changes to show the text PROBE *n* (*n*=probe number). Change this setting only if there is no ID-marking on the indicator label. Otherwise do not change this setting.

Setting the probe type

In cases where an indicator (or a probe) is without an ID-marking, the following probe numbers have to be selected:

<i>Probe</i>	<i>Probe setting</i>
HMP41	1
HMP42	2
HMP44	1...10
HMP45	1
HMP46	2

- change the setting with buttons ▲ and ▼
With the probe HMP44 there is no need to change the setting.
- press ENTER; the display now changes to show the text START. Change this setting only if there is no ID-marking on the indicator label. Otherwise do not change this setting.

Select the function

In cases where an indicator (or a probe) is without an ID-marking on the label the following function selection is made:

<i>Probe</i>	<i>Setting</i>
HMP41	Start 1
HMP42	
HMP45	
HMP46	
HMP44	Start 5

- change the setting with buttons ▲ and ▼
- press ENTER three times; the display now changes to show the following settings (do not change them):

<i>baud</i>	4.8
<i>seri</i>	E.7.1
<i>calib</i>	def (*)

(* when entering the setting *calib*, the value is always 'no'; the factory settings are restored by selecting 'def'. After this, the previously entered adjustment coefficients are no longer valid.

CHAPTER 5

HUMIDITY MEASUREMENTS IN CONCRETE

General about humidity measurements in a drilled hole

The HMP44 probe measures *humidity* of concrete *in a drilled hole*. In equilibrium stage, the humidity of a concrete and air humidity in a drilled hole become same.

Drilling changes the stage of the concrete. This is due to the fact that heat is formed during drilling. (Meantime the humidity of the concrete changes, because of the temperature changes). To reach the equilibrium stage after drilling takes about three days. When the equilibrium stage has been reached, the air humidity in a drilled hole and the concrete humidity become equal. Then it is possible to make the humidity measurement.

For getting more reliable results, it is recommended to have several measurement points.

Measurement depth

Depth of a drilled hole

When drying of a concrete slab takes place from both sides, the minimum depth of measurement (d) is made 20 % of the depth of the slab. When drying occurs from one side only, the measurement depth (d) is 40 % of the depth of a slab. See Figure 5.1.

Humidity profile (Figure 5.1)

The humidity profile of the slab depends on the drying of the concrete, i.e. whether the concrete dries in one or in two directions. In concrete slabs drying in two directions, the humidity is highest in the middle. After coating, the humidity spreads evenly throughout the

slab until it corresponds to readings measured at the depth of approximately 20% of the slab. In concrete slabs drying in one direction only, the humidity is highest at the bottom. After coating, the humidity spreads evenly throughout the slab until it corresponds to readings measured at the depth of approximately 40% of the slab.

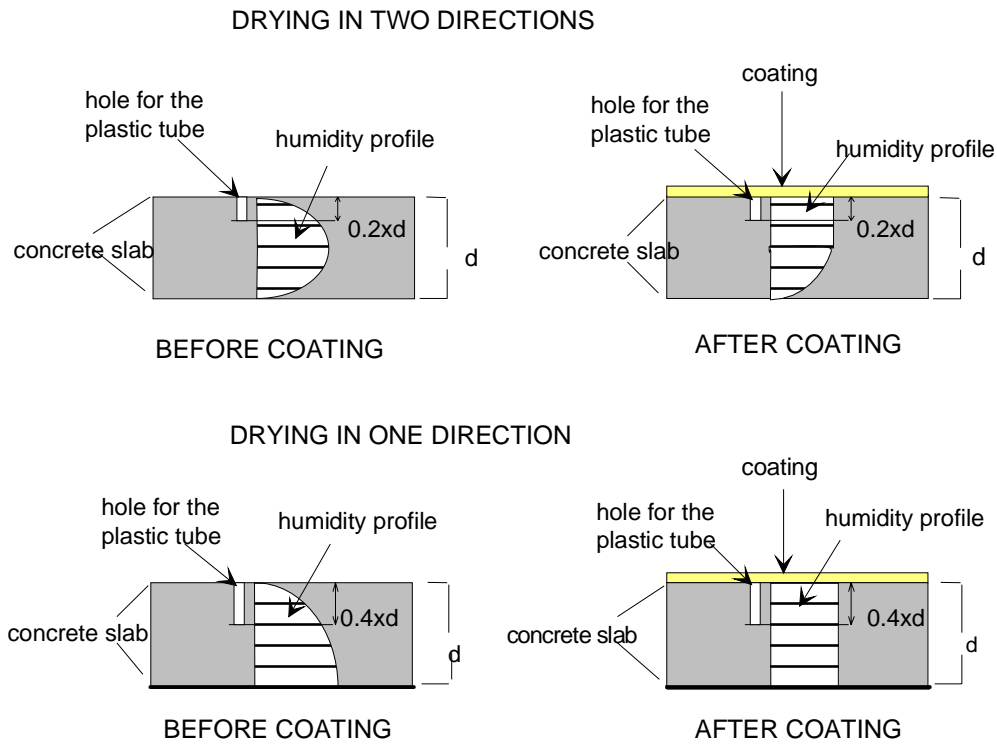

Figure 5.1 Humidity profile before and after the coating

Maximum humidity levels for coating

SisäRYL 2000 Code of Building Practice (RT 14-10668, 2000, ISBN 951-682-506-0) recommends the following maximum humidity levels (at +20°C) for coating of various materials :

Wooden floor coverings

Maximum RH (%)	Coating
60 ¹	Wooden parquet boards without moisture barrier (plastic film) between wood and concrete.
80 ¹	Enlaid wooden floor coverings. Floating wooden floor coverings with moisture barrier (plastic film) between wood and concrete.

¹ SisäRYL 2000 Code of Building practice, RT 14-10668, 2000, ISBN 951-682-506-0, page 332.

Other materials

Maximum RH (%)	Coating
85 ¹	Plastic floor coverings with fibre felt base or cellular plastic base Rubber floor coverings Cork tiles with moisture barrier (plastic film) Textile floor coverings with rubber, PVC or latex base Natural fibre textile floor coverings without base
90 ¹	Plastic tiles Plastic floor coverings without felt or cellular plastic base Linoleum (Cork) Man-made fibre textile floor coverings without base structure
97	Epoxy mass Acrylic mass Polyester plastic mass

¹ SisäRYL 2000 Code of Building practice, RT 14-10668, 2000, ISBN 951-682-506-0, page 318.

Preparations for the measurements

The holes shall be drilled 3 days before the measurements. A plastic sleeve and an installation cover are placed to the hole immediately after drilling. A probe can be placed to the plastic sleeve immediately after drilling or before measurements. Follow the instructions below.

1. Bore 3 days before the measurements at least two holes with diameter of \varnothing 16 mm and sufficient depth, see page 13. Clean the hole thoroughly e.g. by blowing air or with a vacuum cleaner.
2. Press a plastic sleeve into the hole. If you need something to press it with, use e.g. the lid of the installation cover.



Figure 5.1 Pressing the sleeve into the hole

NOTE

Make sure that the sleeve and the probe are not colder than the concrete during installation: this might cause condensation on the probe and the readings can be incorrect.

3. Close the hole by using an installation cover as described in the following or Press an installation cover on the plastic sleeve and make it slide down freely. Press the installation cover against the base so that the sealing presses down slightly. Turn the cover 90° to lock it in place.



Figure 5.2. Locking the cover in place

4. Insert the probe into the sleeve by feeding it in with the cable until it touches the bottom. Close a rubber plug around the cable and seal the sleeve with it:



Figure 5.3 Sealing the sleeve with a plastic plug

5. Fold the cable in the installation cover and close the lid. Leave the probe to stabilize before starting the measurements.

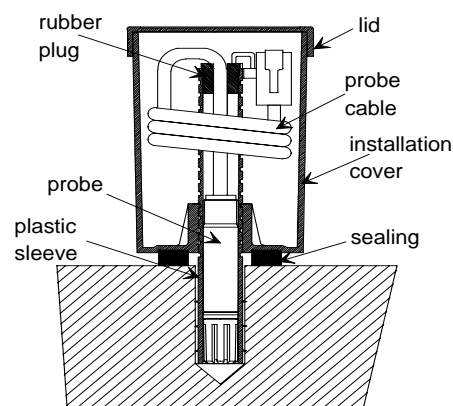

Figure 5.4 Cable folded in the installation cover

Alternatively, you can insert the probe into the sleeve about 30 minutes before starting the measurements. In this case, close the cable lead-through of a rubber plug with its cap as shown in the photo, and seal the sleeve with the plug:

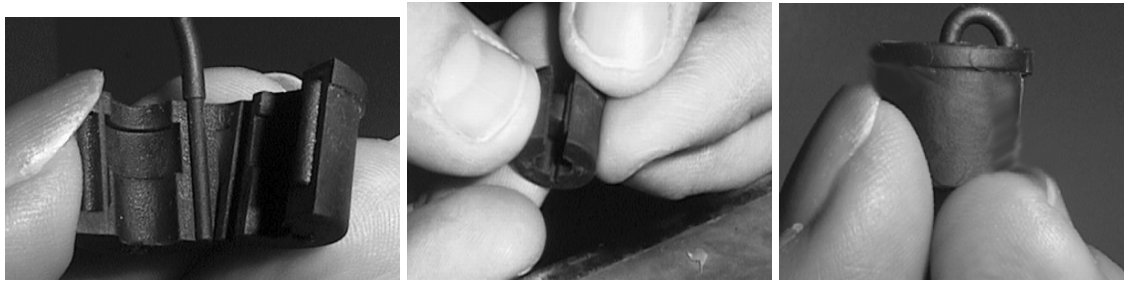
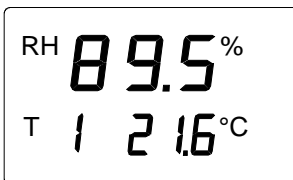

Figure 5.5 Close the cable lead-through of the rubber plug

However, we recommend that you leave the probe into the sleeve as this ensures the best possible reliability of the readings. When the concrete is dry enough and measurements are no longer necessary, pull the probe out with the installation cover and the sleeve.

Starting the measurements

The humidity of the hole reaches an equilibrium with the humidity of the concrete approximately in three days. Before this, the measurements cannot be taken. If the probe has not been left in the sleeve, insert it at least 30 minutes before starting the measurements. Do not start measurements before readings have stabilized. Connect the cable in the connector (PROBE) at the bottom of the HMI41. Then follow the instructions of this manual. Turn the indicator on with the button ON/OFF:



Numbers on the first line indicate the humidity reading and numbers on the second line indicate the temperature reading. The first number on the second line (here **1**) indicates the currently selected probe (1-10). If the individual adjustment coefficients have been entered in the HMI41 memory, make sure that this number corresponds to that marked on the product label. If necessary, change the number on the display: press ENTER and simultaneously the button ▲ (number up) or the button ▼ (number down). When the probe number is correct, release the buttons.

The readings measured by the probe appear on the display. When the measurements have been taken, turn the HMI41 off and disconnect the cable. Fold the probe cable in the installation cover and close the lid carefully. If you do not wish to leave the probe into the sleeve, close the sleeve with the rubber plug.

Measurement readings on display

Relative humidity and temperature readings appear automatically after the battery charge indication.

Other readings (dewpoint temperature, absolute humidity, wet bulb temperature, mixing ratio) appear on the display by pressing the button MODE. If it is pressed once, dewpoint temperature (Td) reading is displayed, and further pressings bring one of the other quantities on the display.

HOLD-mode

Press the HOLD button to freeze the display to show the current readings:

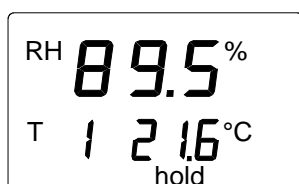

The normal display mode returns with buttons MODE or ENTER.

If the indicator turns itself off with the automatic power-off function during the HOLD mode, it wakes up in the same mode when turned on again. The text 'hold' is blinking and the indicator can be returned to the normal display mode with any button except ON/OFF.

MIN and MAX modes

Press the button HOLD again when the indicator is in the HOLD mode, the minimum readings measured after power-up appear (if the text 'hold' is blinking, the HMI41 must first be returned to the normal display mode, see previous section):

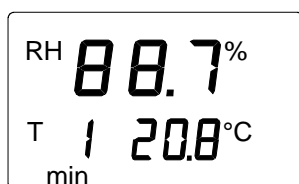

The indicator returns to the normal display mode with buttons MODE or ENTER.

If you press the button HOLD when the indicator is in the MIN mode, the maximum readings measured after power-up appear:



The indicator returns to the normal display mode with any button except ON/OFF.

CHAPTER 6

COLLECTING DATA

The HMI41 indicator can be used for collecting the measurement data. The data is stored in the indicator's non-volatile memory; it is not lost when the indicator is turned off. Please, note also that the automatic power-off function is not active during data collecting even if previously selected. When data collecting has ended, the automatic power-off function becomes active again.

Data collecting modes

The following three modes are used when collecting data:

- REC AUTO: automatic data collecting
- REC CATCH: manual data collecting
- REC READ: reading the measurement results

Entering the data collecting modes

Turn the device ON (by using ON/OFF button) and **immediately (within 1..2 seconds)** after turning on press immediately the button HOLD for at least 5 seconds. The software version and the probe type indication appear for a second, after which the text REC AUTO appears on the display; then release the HOLD button.



REC AUTO is the main display of the data collecting mode. With the button **MODE** you can enter the **REC CATCH** mode (manual data collecting, see page 24) and by pressing **MODE** again, the **REC READ** mode (reading the measurement results, see page 25).

Automatic data collecting mode REC AUTO

Enter the REC AUTO mode as instructed on page 21.

Setting the measurement duration

Press ENTER and a text similar to the following appears on the display:



(previously set duration)

In this mode, you can set the time between the first and the last measurement stored, e.g. 30 minutes or 3 days. When entering this mode, previously set duration time appears on the display. If the previously set duration time is too long for the current battery charge, the longest calculated duration time possible appears instead. This is also indicated with the text 'MAX'. The duration of the measurement can be set from 15 minutes to 7 days. The batteries last for 7 days during data collecting provided that they are of the same type as those delivered with the indicator.

Set the duration with buttons ▲ and ▼. The duration time can be selected in steps according to the following:

- 15 min; 30 min
- 1 - 6 h: each pressing = 1 h
- 12 h
- 1 - 7 d: each pressing = 1 d

If the duration selected is too long for the current battery charge, the text 'BAT' appears. Select a shorter duration time. Press ENTER to set the measurement interval.

Setting the measurement interval

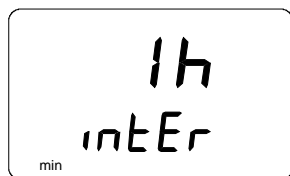

(previously set interval)

In this mode, you can set the time between two measurements stored, e.g. 5 minutes or 2 hours. When entering this mode, previously set interval appears on the display. If the previously set measurement interval is too short for the current memory capacity of the indicator, the shortest calculated measurement interval appears instead. This is also indicated with the text 'MIN'.

Select the interval with buttons ▲ and ▼. The measurement interval can be selected in steps according to the following:

- 1 - 5 min: each pressing = 1 minute
- 10 min; 15 min; 30 min
- 1 - 6 h: each pressing = 1 hour
- 12 h

(Note: Interval can not be set longer than the measurement duration).

The text 'LO' on the display indicates that there is not enough memory for the chosen interval; select a longer interval. Press ENTER and a text similar to the following appears:

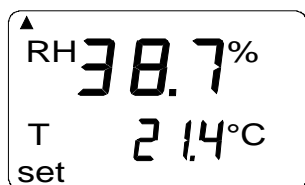

This is the measurement mode with the data collecting feature activated. It can be distinguished from the normal measurement mode by the text 'SET' on the lower left-hand corner of the display. The readings on the display are updated once a minute, and the display is dim except during this updating in order to minimize the consumption. If the indicator is turned off, the measurements stored so far remain in the memory and they can be read by turning the indicator on in the REC READ mode (see page 25). You can end data collecting by pressing ON/OFF.

Manual data collecting REC CATCH

Enter the REC CATCH mode, see page 21.



Press ENTER and a text similar to the following appears:

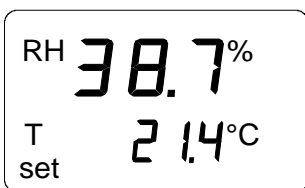

The probe is now taking measurements and you can store the readings at appropriate intervals by pressing the button HOLD. Each time you store a reading, its sequence number in the indicator memory appears for a couple of seconds:



The indicator returns automatically to show the readings. You can store 199 measurement readings in the indicator memory (numbers 1 - 199). In automatic data collecting, you can store 200 readings (0 - 199). End data collecting by turning the indicator off. You can read the readings in the REC READ mode (see page 25). The readings will disappear from the memory when starting a new collecting.

When having several probes, firstly give a number to the probe and then feed the probe individual coefficients to the HMI41 memory (see page 7). Before data reading select the correct probe number and store the reading of the different probes under different data sequence numbers. Write down the corresponding probe and sequence numbers. Note, do not turn the indicator off between the measurements, all the stored data will disappear when starting the REC CATCH mode again.

Reading the measurement results REC READ

Enter the **REC READ** mode as instructed on page 21.



Press **ENTER**, and a text similar to the following appears on the display:

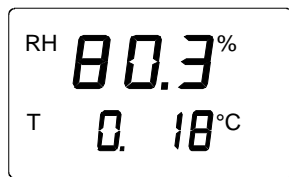

Numbers on the first line indicate the reading of the quantity in question (in this example, RH). The number on the left on the second line (in this example number 0.) is the sequence number of the measurement. This number helps to estimate the time of the measurement during automatic data collecting provided that the starting time and the measurement interval are known. Numbers on the right on the second line indicate the temperature reading measured simultaneously with the reading on the first line; if you wish to see the decimals, press **ENTER**. The reading appears on the display with one decimal:

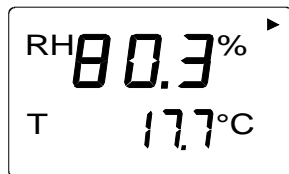

In a couple of seconds the indicator returns to the previous display. Press **MODE** to change the quantity on the first line:

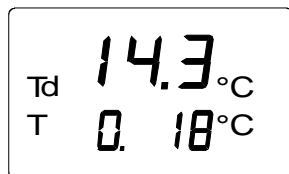

When you press **ENTER** (with any quantity on the first line), an arrow appears on the higher right hand corner of the display:

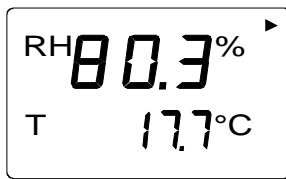

Press HOLD while the arrow is displayed to scroll the measurement results (note that the sequence number changes):

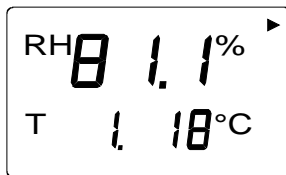

HOLD:

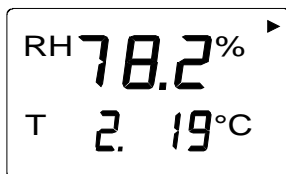

etc.

If the button HOLD is pressed continuously, numbers change in a faster rate.

MIN and MAX in data collecting REC READ mode

When the data collecting REC READ mode has been activated, the HOLD button brings four different modes on the display: MIN HI, MAX HI, MIN LO and MAX LO. These modes indicate the maximum and minimum readings measured for the quantities on the display. HI and LO tell you whether the reading observed is the one on the first line (HI) or the one on the second line (LO). MIN and MAX indicate whether the reading on the display is the minimum or the maximum value. In other words, if the text is MIN HI it means that you are now observing the minimum reading of the quantity on the first line.

By pressing HOLD repeatedly you can change from one display mode to another, and by pressing MODE you can change the quantity on the first line. In all these modes, the decimals of the second line reading are shown by pressing the button ENTER.

Examples:

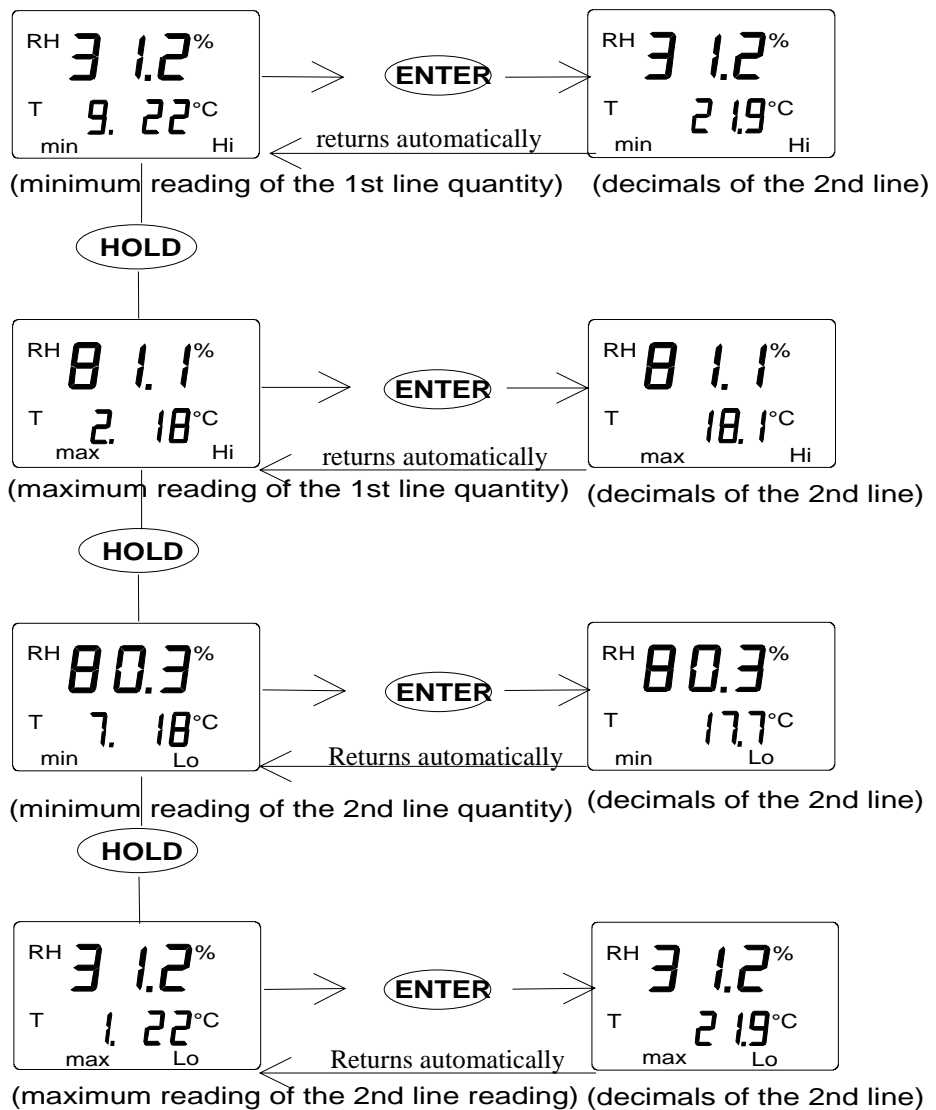

CHAPTER 7

TRANSFERRING DATA TO A PC

The readings that have been stored in the HMI41 memory manually or automatically in the data collecting mode, can be transferred to a computer and then printed if desired. In order to do this, connect a serial connection cable (order code 19446ZZ) to the appropriate connectors on your PC and in the HMI41:



**connect the
serial cable
to the EXT
connector**

Figure 7.1 Connecting the cable

Giving the communication parameters

Give the communication parameters when using this terminal session for the first time; save them for future use. See instructions in the following tables.

Table 7.1 Giving parameters in Windows 3.1

MENU	DESCRIPTION
PROGRAM MANAGER	
↓	
ACCESSORIES	double click
↓	
TERMINAL	double click
↓	
Settings	click
↓	
Communications	click and select parameters (see figure 7.2); click OK
↓	move the cursor to:
File	click
↓	
Save as	click and save settings: type the name of the file (e.g. HMI41) and click OK
Turn the HMI41 on, and follow the instructions on page 32.	

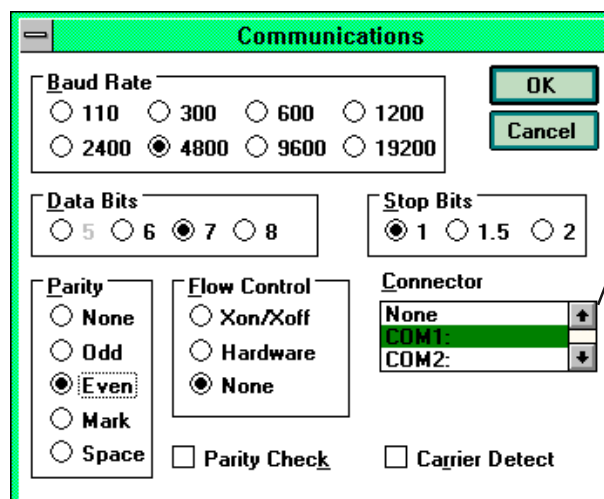

NOTE: select the connector according to your computer. Select the connector first and give then other parameters

Figure 7.2 Giving the communication parameters in Windows 3.1

Table 7.2 Giving parameters in Windows 95/98 and Windows NT

WINDOWS 95		WINDOWS NT	
MENU	WHAT TO DO	MENU	WHAT TO DO
Start		Start	
↓	move the cursor to:	↓	move the cursor to:
Programs		Programs	
↓	move the cursor to:	↓	move the cursor to:
Accessories		Accessories	
↓	move the cursor to:	↓	move the cursor to:
HyperTerminal	click	HyperTerminal	
↓	move the cursor to:	↓	move the cursor to:
Hyperterminal	double click	Hyperterminal	click
↓		↓	
Connection Description	type the name of the connection (e.g. HMI41) in the appropriate field and select an icon if available; click OK.	Connection Description	type the name of the connection (e.g. HMI41) in the appropriate field and select an icon if available; click OK.
↓			
Phone Number	move the cursor to the field CONNECT USING and select ' direct to COM x ' (x = serial port available); click OK	Connect to	move the cursor to the field CONNECT USING and select ' COM x ' (x = serial port available); click OK
↓		↓	
COM x properties	select parameters according to the screen in figure 7.3; click OK	COM x properties	select parameters according to the screen in figure 7.3; click OK
Turn the HMI41 on and follow the instructions on page 32.			

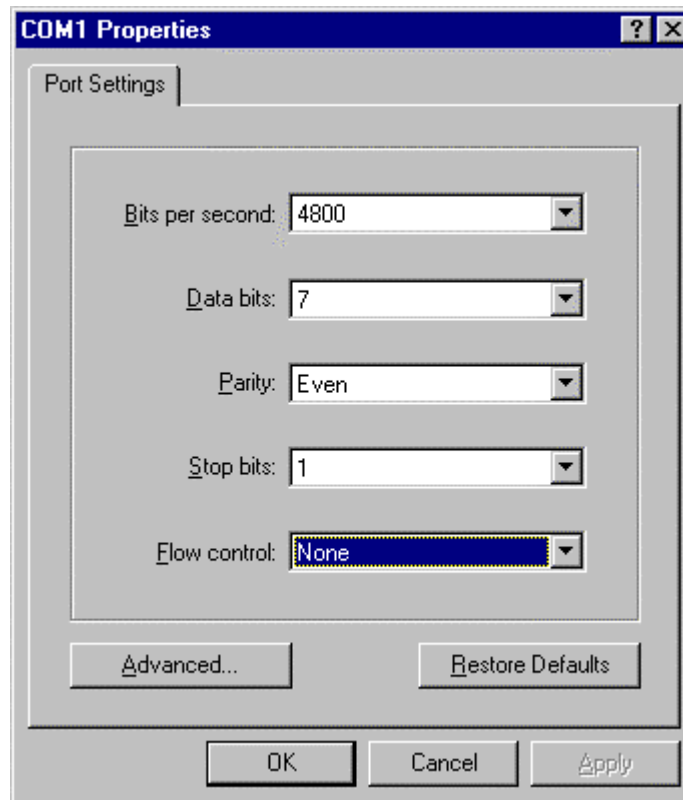

Figure 7.3. Communication parameter selection window.

Transferring the data

When you have given the communication parameters, you can start transferring the data from the HMI41. Note that communication parameters can be stored in the computer for future use. To start transferring the data, make sure that the HMI41 is connected to a serial port of your computer and that the terminal session is open. Turn the HMI41 on with the ON/OFF button. A text similar to the following should now appear on your computer display:

```
HMI41 / 2.02
>
```

Commands

PLAY Transferring the data

To transfer the data on your PC, type PLAY and press ENTER. An example of outputting automatically stored data:

```
>play
Reading Log... OK

data    hh:mm:ss          RH      T      Td
  0     00:00:00      12.54   21.53  -8.48
  1     00:01:00      12.10   21.23  -9.16
  2     00:02:00      12.18   21.18  -9.12
  3     00:03:00      12.12   21.15  -9.21
  4     00:04:00      12.16   21.14  -9.18
  5     00:05:00      12.09   21.12  -9.27
  6     00:06:00      12.09   21.09  -9.28
>
```

An example of outputting manually stored data:

```
>play
Reading Log... OK

data    RH      T      Td
  1     12.10  21.23  -9.16
  2     12.18  21.18  -9.12
  3     12.12  21.15  -9.21
  4     12.16  21.14  -9.18
  5     12.09  21.12  -9.27
  6     12.09  21.09  -9.28
>
```

If you know the starting time of the automatic data collecting, you can enter it with the command and get an output showing the actual time of measurement. For example:

```
>play 15:05
Reading Log... OK

data    hh:mm:ss          RH      T      Td
  0     15:05:00        8.52   23.69  -11.70
  1     15:06:00        9.58   23.66  -10.26
  2     15:07:00        9.60   23.50  -10.35
  3     15:08:00        9.61   23.30  -10.48
  4     15:09:00        9.65   23.25  -10.47
  5     15:10:00       11.22   23.41   -8.44
  6     15:11:00        9.93   23.30  -10.08
  7     15:12:00        9.92   23.22  -10.15
>
```

CPLAY Setting characters between decimals and fields

With the CPLAY command, you can select what you want to appear between decimals and various fields. An example:

```
>cplay
Desimal separator : .
Field separator   : TAB
example:
  1     01:00:00        38.72   21.61   7.01
>
```

To change the output, type CPLAY, then the character you wish to appear between decimals, then the character you wish to use between fields and then <cr>. An example:

```
>cplay ,          <cr>

Desimal separator : ,
Field separator   : TAB

example:
  1     01:00:00        38,72   21,61   7,01
>
```

HELP Outputting available commands and their contents

If you wish to see which commands are available, type HELP and press ENTER. The following list appears:

```
>help
Available commands :
HELP      ?          PLAY      CPLAY
Type HELP <command_name> for more help
>
```

To see the contents of each command, type HELP, command name (e.g. PLAY) and press ENTER; this brings an explanation of the command and its usage on the display:

```
>help play

Command : PLAY
Purpose : Send recordings from memory to serial port
Usage   : PLAY hh:mm <cr>, hh:mm = rec starting time (optional)

if command is used without parameters it uses default setting
>
```

? Outputting the HMI41 settings

If you need to know which parameters and settings are currently stored in your HMI41 indicator, type ? and press ENTER:

```
>?

HMI41 / 2.01
Serial number : A0000000
Output units  : metric
Baud P D S   : 4800 E 7 1 FDX
Pressure     : 1013.25
Auto Off     : 5
Probe       : 2
Start-up mode : 1
4.th variable : none
>
```

To exit the terminal session, go to FILE menu and select EXIT. Confirm that you wish to quit and then select whether you wish to store the parameters of this session for future use or not (SAVE - YES/NO)

CHAPTER 8

CALIBRATION

Calibration interval

The HMP44 probes are calibrated at the factory. A new probe should be calibrated first time 6 months from implementation, after that annually. In case the adjustment is needed, contact Vaisala SSD Service or local Vaisala representative (see Chapter 9, Maintenance).

Calibration coefficients

During calibration, the HMI41 calculates new adjustment coefficients for the probe and the previously set coefficients are no longer valid. It is recommended to check the new coefficients and write them down. The coefficients can be checked by pressing ENTER for about 5 seconds continuously and the offset correction is displayed; press ENTER once more and the gain correction is displayed.

Calibration mode

The calibration can be performed with Vaisala HMK15 calibrator and saturated salt solutions. Check the reference values from the calibration table below:

Temperature	°C	15	20	25	30	35
LiCl	%RH	*)	11.3	11.3	11.3	11.3
NaCl	%RH	75.6	75.5	75.3	75.1	74.9
K ₂ SO ₄	%RH	97.9	97.6	97.3	97.0	96.7

Greenspan's calibration table

*) Do not use or store the LiCl solution in temperatures below +18°C as its humidity equilibrium may change permanently

Calibration procedure is included in the HMI41 setup mode. Note that the calibration is done for currently selected probe.

Enter the setup mode, refer to Enter the setup menu on page 9.



After a few seconds, the text changes automatically to show the following:

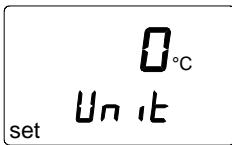

Press ENTER repeatedly until the following appears:

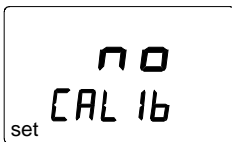

This indicates that no calibration has been selected. In addition to this, there are five calibration types available. Select the desired type with buttons ▲ or ▼. All selections are acknowledged with ENTER. In the table below, you can find a summary of all the calibration options.

	Default calibration restores the factory settings of the humidity and temperature calibrations.
	One point humidity calibration; select this for performing a humidity calibration at one point (not instructed).
	Two point humidity calibration; select this for performing a humidity calibration at one point (see section Two-point humidity calibration on page 37).
	Entering the offset correction manually; corresponds to the mode explained in Section Feeding the offset correction on page 8.
	Entering the gain correction manually; corresponds to the mode explained in Section Feeding the gain correction on page 8.

Two-point humidity calibration

In two-point humidity calibration, two accurate references (e.g. the HMK15 Calibrator) are needed. Leave the reference instrument and the probe at the calibration site for at least 1 hour so that the probe temperature stabilizes to the room temperature. Start the calibration by inserting the probe to the lower reference humidity. In setup mode press ENTER repeatedly until the following is displayed:

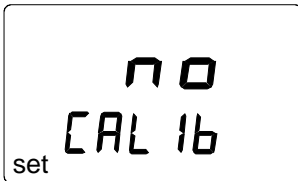

Then press MODE three times, and the following appears:

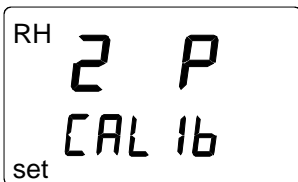

Press ENTER to activate the two-point humidity calibration mode. A message similar to the following appears with the first line blinking:

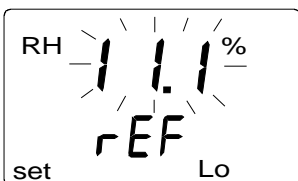

The blinking number indicates the value of the lower humidity reference stored in the HMI41 memory. Check the salt chamber temperature, read the closest humidity value in the calibration table and adjust the display with buttons ▲ and ▼ to correspond to the value given in the table. For example, if the temperature of the LiCl salt chamber is 22 °C, adjust the value to 11.3 %RH:

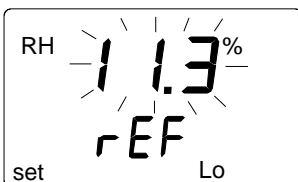

Press ENTER, and the HMI41 shows the value that the probe is currently measuring. Wait for the reading to stabilize (about 30 minutes) and then press ENTER. Now the lower humidity value is corrected to the given low reference. Press ENTER again to conclude the

lower point calibration. A message similar to the following appears with the first line blinking:

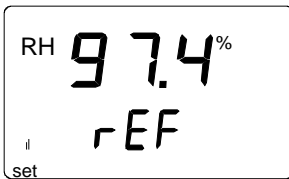

The blinking number indicates the value of the higher humidity reference stored in the HMI41 memory. Insert the probe to the higher reference humidity. Check the salt chamber temperature, read the closest humidity value in the calibration table and adjust the display with buttons ▲ and ▼ to correspond to the value given in the table. For example, if the temperature in the calibrator's NaCl salt chamber is 20.5 °C, adjust the value to 97.6 %RH:

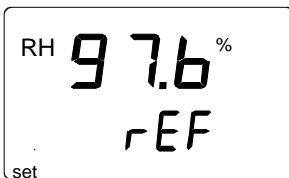

Press ENTER and the HMI41 indicator shows the value that the probe is currently measuring. Wait for the reading to stabilize (about 30 minutes) and press ENTER. Now the higher humidity value is corrected to the given high reference. Press ENTER again to conclude the calibration. If the calibration has been successful, the following message appears:



The correction data has now been calculated and stored in the HMI41 memory. The HMI41 returns automatically to the basic display and it can be turned off. If the correction data differs from the factory settings, an arrow in the upper right-hand corner is displayed showing that the correction has taken place.

If the message *“cal pass”* does not appear (instead, some other text may appear, e.g. *“too close”*, *“err offset”* or *“err gain”*), the correction has not been stored in the memory. The error may be due to an incorrect reference value or to measured values that are out of the range.

CHAPTER 9

MAINTENANCE

Replacing the HUMICAP®180 sensor

Remove damaged sensor and insert a new one. Handle the sensor from the plastic frame; do not touch the sensor plate. Calibrate the probe (with a new sensor) with the calibrator HMK15. The probe can be sent to Vaisala service for sensor change.

Replacing the filter

The combination of a grid (of the probe head) and the membrane filter can be changed if needed (order code 17039HM).

Vaisala SSD Service Centres

Vaisala SSD Service, Vanha Nurmijärventie 21, FIN-01670 Vantaa, FINLAND,
Phone: +358 9 8949 2658, Fax +358 9 8949 2295

Vaisala KK, 42 Kagurazaka 6-Chome, Shinjuku-Ku, Tokyo 162-0825, JAPAN,
Phone: +81 3 3266 9611, Fax +81 3 3266 9610

Vaisala Inc., 100 Commerce Way, Woburn, MA 01801-1068, USA
Phone: +1 781 933 4500, Fax +1 781 933 8029

Internet: <http://www.vaisala.com>

Technical support: ssdservice@vaisala.com

CHAPTER 10

TROUBLESHOOTING

Erroneous readings

If any of the following points is neglected, the readings may result erroneous. Therefore, follow these instructions carefully:

- clean the hole carefully (by blowing air or with a vacuum cleaner)
- follow the indications of the recommended hole depths (see page 13)
- make sure that the probe is not colder than the concrete: this causes condensation on the probe and evaporation may take very long (see page 6)
- replace worn plastic sleeves
- make sure that the lid of the installation cover and the rubber plug are carefully closed
- calibrate the HMP44 at regular intervals (see page 35)
- let the probe stabilize (see page 18)
- wait three days after drilling to achieve air humidity equilibrium

Trouble shooting

If there seems to be something wrong with the HM44 or error messages appear on the HMI41 display, please consult the short list next page for trouble-shooting. The HMI41 goes through a continuous self-diagnostic procedure. If any problems occur, it displays the corresponding error message:

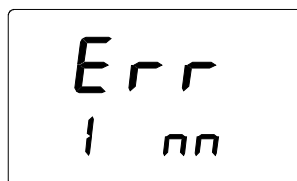

where nn = the number indicating the error (the first number, here 1, indicates the probe)

In the following, a short list for trouble shooting:

PROBLEM:	WHAT TO DO:
the display is blank	<ul style="list-style-type: none"> • check the batteries • if the batteries are in order, contact Vaisala or a Vaisala representative
the display is dim	<ul style="list-style-type: none"> • during automatic data collecting, the display is dim except when the readings are updated (once a minute)
readings seem to be wrong	<ul style="list-style-type: none"> • let the probe stabilize (see page 18) • make sure that the probe cable is correctly connected to the HMI41 • check that the grid and the filter are clean • if the individual adjustment coefficients have been entered (there is an arrow on the display), make sure that the probe number on the display and in the product label correspond (see page 8). • make sure that the HMI41 function is Start 5 with probe HMP44 (see page 12) • make sure that the adjustment coefficients are correct (see page 7) • check that there is marking [ID] in the HMI41 indicator label (and in the probe). If not, please change the settings (see page 12)
you have accidentally changed some settings	<ul style="list-style-type: none"> • enter the setup mode (see page 9) select the setting with buttons ▲or ▼.

CHAPTER 11

SPARE PARTS AND ACCESSORIES

Order code	Description
HMP41	RH & T probe; for fixed mounting
HMP42	RH & T probe; for tight spaces
HMP44	RH & T probe with 0.3 m cable
HMP44L	RH & T probe with 2.7 m cable
HMP45	RH & T probe; cable model
HMP46	RH & T probe; cable model for dirty or hot processes
HMI41	Humidity and temperature indicator
HUMICAP [®] 180	Humidity sensor
17039HM	Membrane filter
19266HM	Plastic sleeve, 12 pcs
19267HM	Rubber plug, 12 pcs
19268HM	Installation cover and lid, 3 pcs
HM26849	Carrying case (HM44/L and accessories; HMI41 and HMP46)
HM36736	Carrying case (HMI41, HMP41 and HMP45)
HM27104	Carrying case (HMI41 and HMP42)
19446ZZ	Serial interface cable for HMI41
19116ZZ	Calibration cable (for HMD/W60/70, HMP140 series)
19164ZZ	Calibration cable (for HMP230 series)
19165ZZ	Calibration cable (for HMD/W20/30, HMP130 series)
HMK15	Humidity calibrator

Optional probes

- **HMP41** probe for measuring humidity and temperature in various applications, for example in spot checks.
- **HMP42** probe head has a diameter of only 4 mm and is 23.5 cm long. This probe structure is specially for measurements in very tight places, e.g. in joint spaces between tiles or in air conditioning channels as well as for measuring the equilibrium humidity of e.g. timber
- **HMP44L** for measuring humidity in concrete and other structures .
- **HMP45** probe for measurements in channels and other places that are difficult to reach and therefore require a probe head with cable.
- **HMP46** consists of a 32 cm long probe head of stainless steel; the HMP46 is optimized for measurements in relatively high temperatures (up to +100°C, temporarily even +180 °C), in dirty processes and in general in applications that require a robust probe structure.

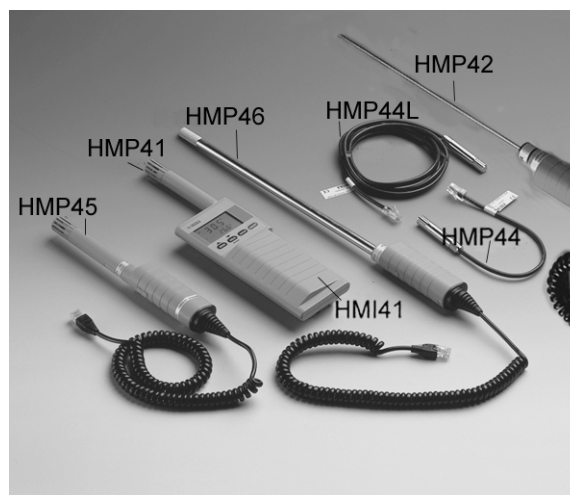

CHAPTER 12

TECHNICAL DATA

HMP44 probe

Humidity

Measurement range	0...100 %RH non-condensing
Accuracy at +20°C:	±2 %RH (0...90%RH)
	±3 %RH (90...100%RH)

Temperature dependence:
^%RH

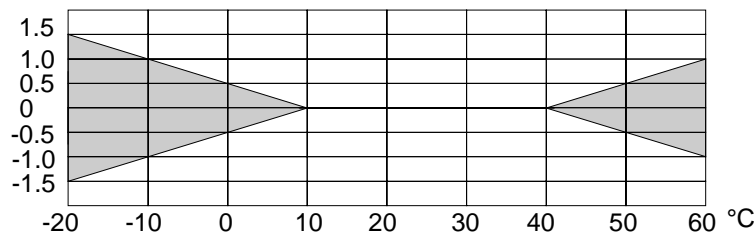

Typical long-term stability in air	1 %RH/year
Response time (90%) at +20°C in still air	15 seconds
Humidity sensor	HUMICAP®180

Temperature

Operating temperature	-40...+60 °C
Measurement range	-20...+60 °C
Accuracy at +20 °C	±0.4 °C

Accuracy over the entire range:

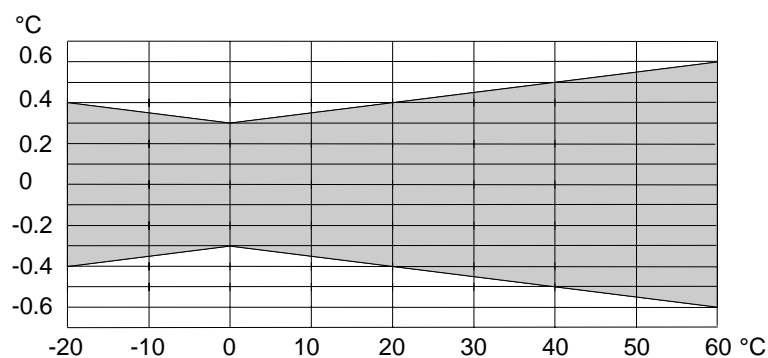

Temperature sensor

Pt1000 IEC 751 Class B

General

Cable length:	
HMP44	0.3 m
HMP44L	2.7 m
Probe diameter	12 mm
Probe length	69 mm
Operating temperature range of electronics	-40...+60 °C
Housing material	ABS plastic
Housing classification	IP65 (NEMA 4)
Sensor protection	membrane filter 17039HM
Weight:	
HMP44	50 g
HMP44L	120 g

HMI41 indicator

Maximum measurement error caused by the indicator at 20 °C:	
humidity	±0.1 %RH
temperature	±0.1 °C
Calculated variables	dewpoint temperature, absolute humidity, wet bulb temperature, mixing ratio
Resolution	0.1 %RH; 0.1 °C
Power supply	4 batteries, type AA (IEC LR6)

Battery operation time	72 h continuous use
Operating humidity range	0...100 %RH non-condensing
Operating temperature	-20...+60 °C
Storage temperature	-40...+70 °C
Display	two line LCD
Housing material	ABS plastic
Housing classification	IP 53 (with connectors blocked)
Connector type	modular connector
Weight (incl. batteries)	300 g



The guarantee does not include the normal wear of the plastic sleeves, installation covers and rubber plugs.

APPENDIX 1: Example of a calibration certificate.



D029en-A

CALIBRATION CERTIFICATE

Instrument	Humidity and temperature probe
Model	HMP44
Serial number	V4750039
Manufacturer	Vaisala Oyj
Date	2000-11-24

The humidity and temperature outputs of the device above were compared to two factory working standards at values given below. The comparisons were made at room temperature at the Vaisala factory. All results are traceable in terms of dewpoint to NPL (National Physical Laboratory, United Kingdom) and in terms of temperature to MIKES (Finnish National Laboratory for Temperature, Finland).

Measurement results using adjustment coefficients:

offset
gain

0.3
1.030

(use 1.03 for HMI41 program versions 1.4 or older)

**Adjustment
coefficients**

Humidity	reference humidity	observed output
	74.2 %RH	74.3 %RH
	45.2 %RH	45.7 %RH
	0.3 %RH	0.3 %RH
Temperature	reference temperature	observed output
	22.39 °C	22.39 °C

For Vaisala Oyj

Technician

Vaisala Oyj
Vanha Nurmijärventie 21
FIN-01670 Vantaa, Finland

Tel. (+ 358 9) 894 9658
Telefax (+ 358 9) 894 9295
<http://www.vaisala.com>

Domicile Vantaa, Finland
Trade Reg. No. 96.607

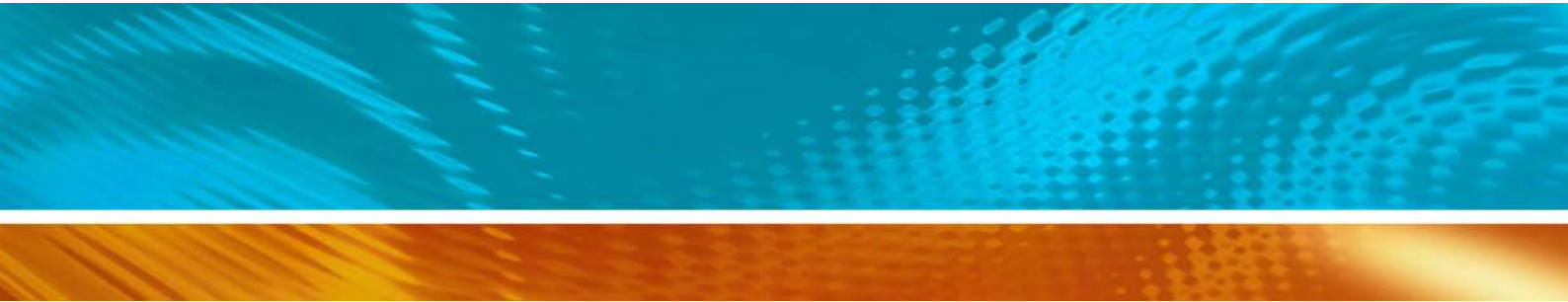

www.vaisala.com

